

CONTROL 
TECHNIQUES

**INSPIRED
MACHINES.
TRUSTED
PARTNERS.**

EMPOWERING INNOVATORS TO MOVE THE WORLD,
ONE REVOLUTION AT A TIME

DRIVE OBSESSED

GROW AND INNOVATE

SMARTER RELATIONSHIPS STAY THE COURSE

Nidec and Control Techniques understand the tough challenges faced by Original Equipment Manufacturers (OEMs).

We make it our priority and mission to take on those challenges and turn them into opportunities for you to excel and stand out from the crowd.

Control Techniques are the masters of world firsts, engineering the first Digital DC drive in 1986, the first Flux Vector Drive in 1989 followed by the first universal AC/Servo Drive in 1996. Since then we have continued to grow and innovate from drives designed to fit the smallest spaces resulting in overall machine footprint reduction to the new multi-protocol solution.

Taking advantage of Nidec businesses globally means creating the perfect solution for OEM machine builders has become second nature to Control Techniques. We pride ourselves on our ability to provide a full range of components, with off the scale service and support to positively build and strengthen partnerships and working relationships.

STRONG SOLUTIONS. FOR A CONNECTED WORLD

Flexibility of communications.

Control system technology is becoming more and more of a necessity as businesses and factory floors use products and devices from different manufacturers.

Control Techniques operates an open communication philosophy aiming to ensure that OEM's can seamlessly integrate Control Techniques drives into any system no matter what other manufacturers products are being installed. Don't be inhibited by end user requests to use specified products, rest assured Control Techniques drives can talk with any PLC or IPC in the market today.

Our proven product development process is used to define and refine proposals, ensuring all aspects from product/solution development, testing and delivery through to life cycle management and operations, perform as promised.

The multi-protocol capability of our ethernet-enabled high-performance and servo drives brings even more performance and extends the range of supported applications and topologies. Using only the standard on-board communications it is possible to realise a system with an HMI connected via Modbus TCP/IP, simultaneously with a high performance connection to a central PLC using EtherNet/IP or PROFINET RT.

Additionally, inter-axis synchronisation using RTMoE delivers the ability to implement complex, highly accurate electronic line-shaft applications at a fraction of the cost of solutions available on the market today.

MACHINE ARCHITECTURE

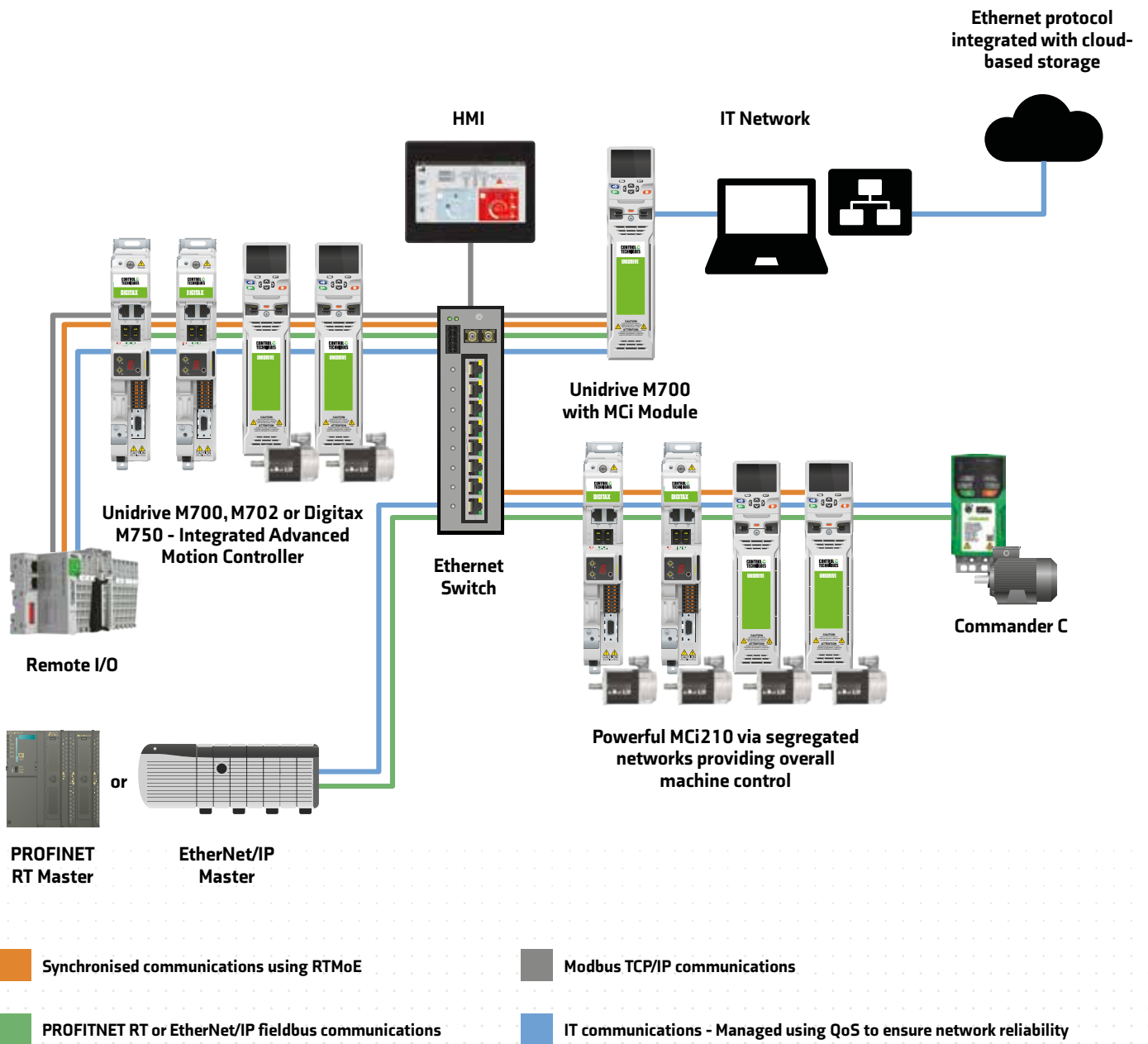

THE FUTURE. SIGNED, SEALED, DELIVERED.



Globally organised expertise, development and support.



Drive sales, technical support, repair and application expertise



Country Partners

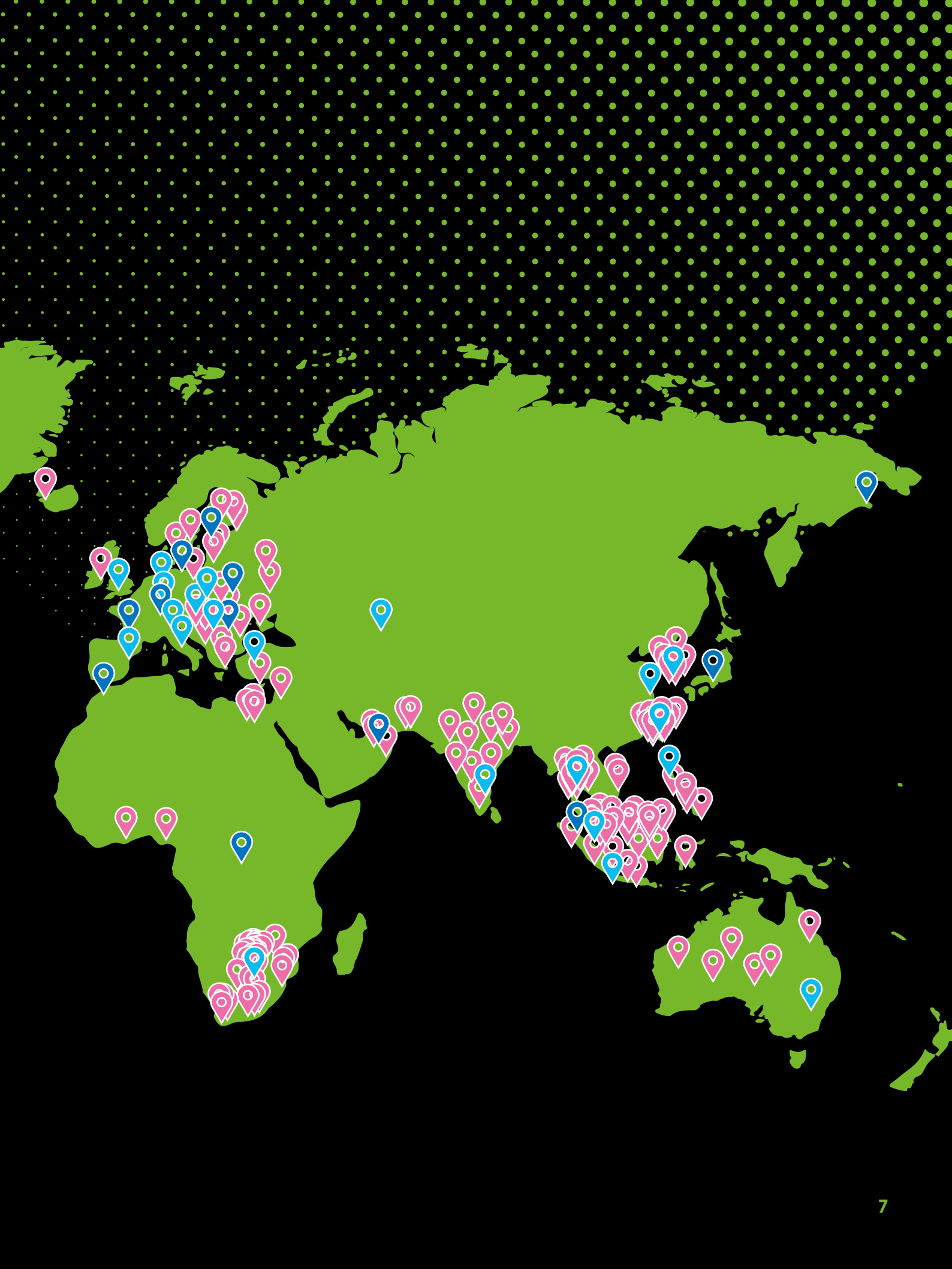

FLEXIBILITY. ADAPTABILITY. SCALABILITY.

Total Solution Expertise



Drives



Motors



Gearboxes



Motion



Automation



Connection

✓ Dedicated OEM Account Management

✓ Matched Drives and Motors Technology

✓ Scalable Automation Solutions

✓ Local Knowledge

✓ Local Service

✓ Local Experience

Our Strategy:

Accelerate our customers' growth and profitability

Align with the globalisation of our customers

Work with new OEMs and grow with them across a wide range of focused industries

Industries and Applications Expertise



Elevator & Cranes Solutions



Material Handling



Robotics



AGV

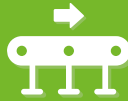

Conveyor Control Systems



Test Stands & Electric Vehicles



Printing Machines



Packaging Machines



Textile Machines



HVAC Systems



Compressors & Vacuum Pumps



Industrial Refrigeration



10K+

OEM Customers



Countries



Drive Centres



Country Partners

400+
Product Development Engineers Worldwide

USING OUR NETWORK TO DRIVE YOUR NETWORK

Extensive global presence ensures we are close by to support local installations, wherever they are in the world.

With over 45 years of experience in the industry, we have well proven capabilities in providing local support and application development to OEM's worldwide.

As an organisation we offer:

- A deep focus on and knowledge of the key sectors in both process and discrete manufacturing industries
- An excellent global infrastructure which provides:
 - i. Global manufacturing and R&D footprint
 - ii. Local technical and sales support through our global Drive Centres
 - iii. Distributors and Country Partners network
- Highly flexible and comprehensive product ranges, with options and opportunities for customisation
- Technical and engineering expertise worldwide
- Well-formed, resourced and proven new product development processes

With dedicated OEM account managers, supported by our entire organisation, we can help you develop product and service solutions that add value to your business.

This includes enhancing profitability, stream lining your processes and supporting you to meet and exceed your commercial goals.



YOU NAME IT. WE'LL NAIL IT.

By providing the level of support expected by an OEM time and time again, we meet our joint business goals, building trust and long lasting partnerships that benefit both parties and ultimately deliver value to our customers and an enhanced experience to users of our technology.

Globally organised expertise, development and support.



Drives and Motors Technology

Enhancing performance and optimizing energy efficiency, offering industry-specific solutions for all customer requirements with best-in-class reliability.



Automation Solutions

Industry-focussed small machine automation projects up to complete automation & electrical turnkey solutions.



Drives and Motors Services

From audit & consultation, commissioning & start-up to maintenance and training, ensuring total support throughout the lifetime of your application to guarantee peak performance.



OEM Account Management

Jointly developed customized solutions and strategic operations to meet the specific market requirements of our OEM customers.

YOUR PRODUCT YOUR BRAND

Custom branded drives and motors, elevate yourself to the forefront.

Whether you have a simple application or a complex production line project, if you need tailored solutions to bring the best performance out of your equipment, Control Techniques is the partner you have been looking for.

From software customisation, to bespoke design of servo motors, gearboxes or mechatronic packages, we can work with you to achieve the optimum performance.

Our local team of sales consultants and application engineers will work in partnership with you to create unique value-added solutions that can make you stand out from the crowd.

We will work with you from the initial concept all the way through to design, development, implementation & installation anywhere in the world.

We have been drive specialists since 1974 and as part of the Nidec group, the world's number one motor manufacturer, numbering leading brands in the design of mechanical and

mechatronic solutions, we have a deep understanding of OEM needs and can offer the best solutions on the market. In the first 45 years of our journey, we have partnered with multiple OEMs, working together to develop hundreds of specific solutions in various application areas.

As part of our partnership program we can also offer a private label service(*), so that our product can contribute to building your brand recognition, while preconfigured / pre-parametrized products empower you to offer fast and efficient after-service to your final customer.

(* subject to minimum-volume conditions)

NO NONSENSE BESPOKE SOLUTIONS

Customised motors and gearboxes for an all round, real solution.

Optimised powertrain solution

When designing a powertrain solution, precision and performance must be combined with high availability and resilience.

At Control Techniques we can help you combine our range of high performing servo motors and drives, with our precision planetary or bevel gearboxes to create an optimised package that delivers long-term efficiency and reliability with high repeatable accuracy.

If it's not in our catalogue, we can design it for you

No matter what industry you are in, with our long-standing expertise and flexible product portfolio, we are committed to delivering the best possible engineering solution to meet your application requirements.

If a suitable motor or gear is not available in our catalogue, our engineering team can customise it or create a bespoke design to suit your needs. With on-board drive programming and System Integration modules our local application team can help you design the most efficient solution.

We offer comprehensive know-how in all relevant areas – from the specifications and the first sketch up to the manufacturing of the zero series including intensive test operations. Our quality management system guarantees highest quality and cost certainty.

THE WINNING MENTALITY OF **ONE NIDEC**



Control Techniques has been at the forefront of drive technology for over 40 years. We empower innovators to move the world, one revolution at a time.



Over several decades, CTD has developed generations of high performance motor ranges to meet the design, the performance, the functionality and the cost specifications of a wide of applications and industries.



Bevel gears create powerful systems using housings, shafts, flanges and bearings. Your complex design is in good hands with Nidec Graessner - we've been working on intelligent concepts for over 65 years.



KB Electronics manufacturers off the shelf and custom OEM AC Drives Inverters, DC Drives, Fan Speed Controls - motor drives from fractional to 30 HP.

**LEROY
SOMER**

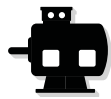

Leroy Somer design, develop and manufacture scalable, customised product & service solutions for OEMs supported by a global presence with operations and engineering & development teams in Europe, China, India & Americas.

**Nidec
DRIVE SYSTEMS**

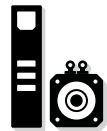

Nidec Drive Systems (NDS) is a global manufacturing enterprise that provides custom engineered control, motor and drive system solutions for world class customers in electric vehicle, commercial floor care, material handling, aerial work platforms, water pumping, and renewable energy.

**Nidec
MOTION CONTROL**



The Nidec Motion Control product line features a full line of high efficiency motors, large and small, which serve industrial, residential, and commercial markets in the following applications.

RoboteQ



Welcome to the world's most innovative, complete and integrated Motion Control, Navigation Sensors and Power Management solutions for mobile robots.

**Nidec
INSTRUMENTS**

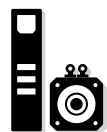















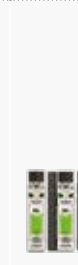

NIDEC SANKYO's portfolio includes micro motors, stepping motors, as well as card readers, industrial robots and a broad array of other equipment.





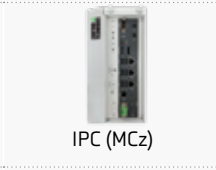

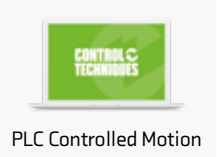







**Nidec
DRIVE TECHNOLOGY**

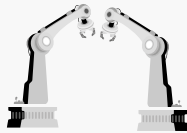

Providing high precision motion control speed reducers, Automatic Guided Vehicles (AGV's), power transmission equipment, press machines and measuring instruments.

SHAPING THE FUTURE OF INDUSTRY

		LOW VOLTAGE AC				
		General Purpose	Pumps, Ventilation & Compression		High Performance Motors	
		Commander C, Commander S & KB	F600 & H300	Free Standing Drive	Elevator E300	
Drives						
Motors					 <p>E27</p>	
Gears						
Accessories	 <p>HMI</p>	 <p>Remote I/O</p>	 <p>IPC (MCz)</p>	 <p>Machine Control (MCe)</p>		
Standard Solutions	 <p>PLC Controlled Motion</p>	 <p>Winders</p>				

		ULTRA LOW VOLTAGE AC			DC
Control	Servo				High Performance DC Drives
Unidrive M	Digitax	Roboteq		AGV and Robotic Solutions	Mentor MP
					
					
					

PACKAGING LINE WE'VE GOT IT WRAPPED UP

Conveyors

Commander C • MCI option modules
Commander S



Labelling

Unidrive M • Digitax HD • MCI option modules • LS Motors • Unimotor hd

Palletiser

Unidrive M • Digitax HD • MCI option modules
 LS Motors • Unimotor hd

AGV

Digitax HD • Unimotor hd

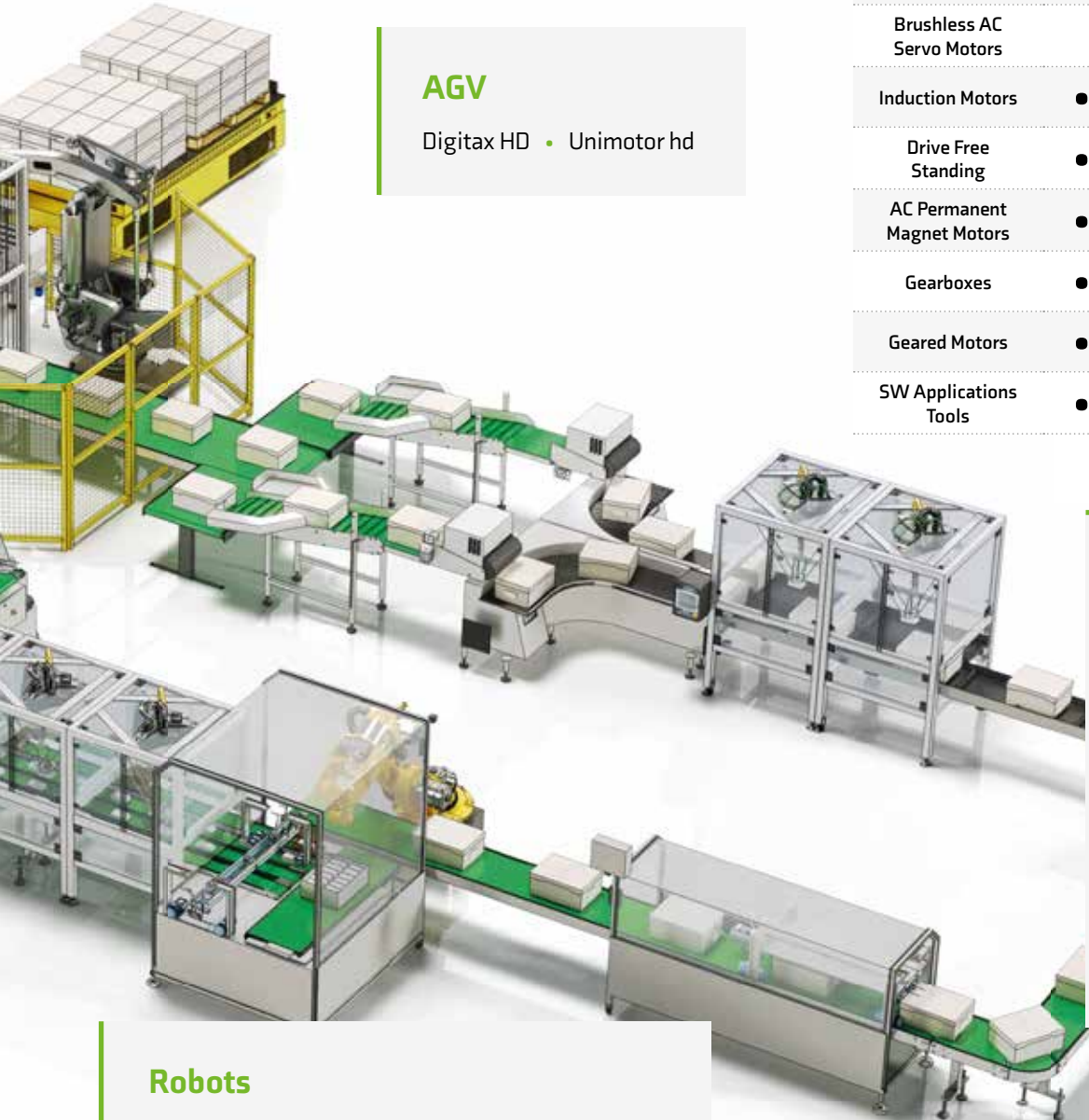

Robots

Digitax HD • Unimotor hd • Shimpo gearboxes

Food, Beverage and Packaging	Process	Primary	Secondary	Tertiary
General Purpose Drive	●	●	●	●
High Performance Drive	●	●	●	●
Servo Drives		●	●	●
Brushless AC Servo Motors		●	●	●
Induction Motors	●	●	●	●
Drive Free Standing	●			
AC Permanent Magnet Motors	●			
Gearboxes	●	●	●	●
Geared Motors	●	●	●	●
SW Applications Tools	●	●	●	●

- ✓ Conveyors
- ✓ Filling
- ✓ Sorting
- ✓ Printing
- ✓ Winding
- ✓ Robotics
- ✓ Labelling
- ✓ Material Handling
- ✓ Palletising
- ✓ AGV's

MATERIAL HANDLING BECAUSE STUFF ISN'T JUST STUFF

Material Handling	Conveyor	Robot IC	AGV
General Purpose Drive	●		
High Performance Drive		●	
Servo Drives		●	●
Brushless AC Servo Motors		●	●
Induction Motors	●		
Drive Free Standing			
AC Permanent Magnet Motors	●		
Gearboxes	●	●	●
Geared Motors	●	●	●
Robotic and AGV Solutions		●	●
SW Applications Tools	●	●	●



Robots

M700 • Digitax HD • Unimotor hd
Frameless Motors

- ✓ Conveyors
- ✓ Lifting
- ✓ Sorting
- ✓ Stackers
- ✓ Cranes
- ✓ AGV
- ✓ Robots
- ✓ Automated Warehouse



Conveyors

- Commander C
- Commander S
- M700
- Digitax HD
- Unimotor hd
- ULV Drive & Motors

AGV & Shuttles

Wheel Unimotors • Drives
Power Management & Navigation Sensors

HVAC/R

MORE THAN A BREATH OF FRESH AIR

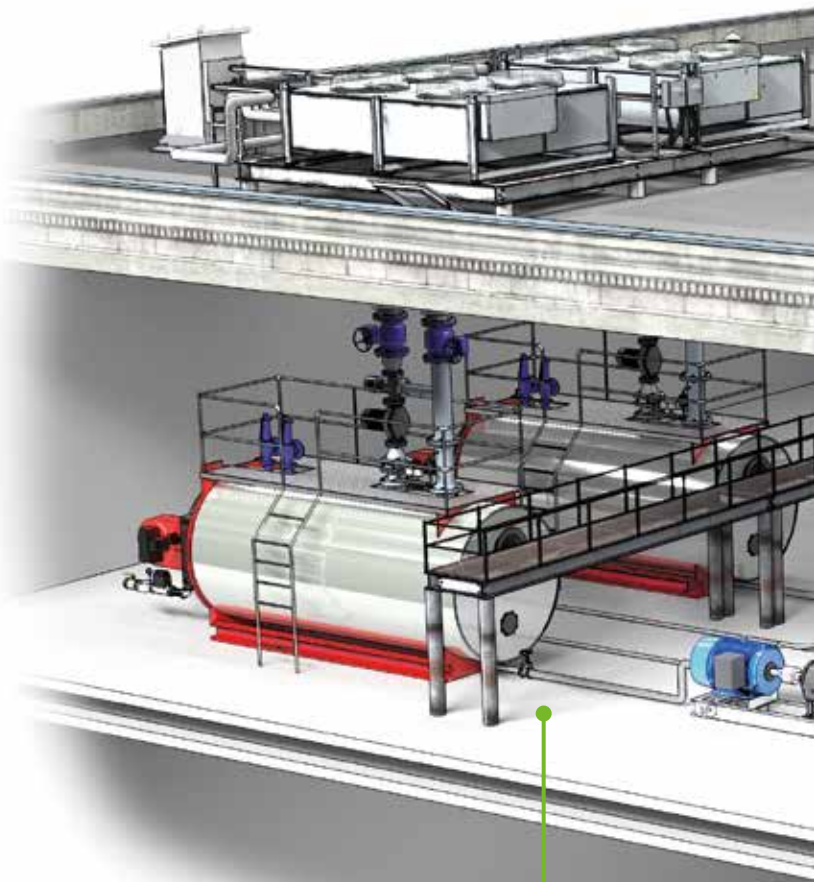

HVAC/R	Heating	Ventilation	Air Conditioning	Refrigeration
General Purpose Drive	●	●	●	●
High Performance Drive				
Servo Drives				
Brushless AC Servo Motors				
Drive Free Standing	●	●	●	●
AC Permanent Magnet Motors	●	●	●	●
Gearboxes				
Geared Motors				
SW Applications Tools	●	●	●	●

Pump Drive F600
HVAC Drive H300

HVAC Drive H300

Pump Drive F600

Commander C

Commander S

- ✓ Heat generation
- ✓ Heat distribution
- ✓ Ventilation
- ✓ Air conditioning
- ✓ Refrigeration
- ✓ Water pressure boosting

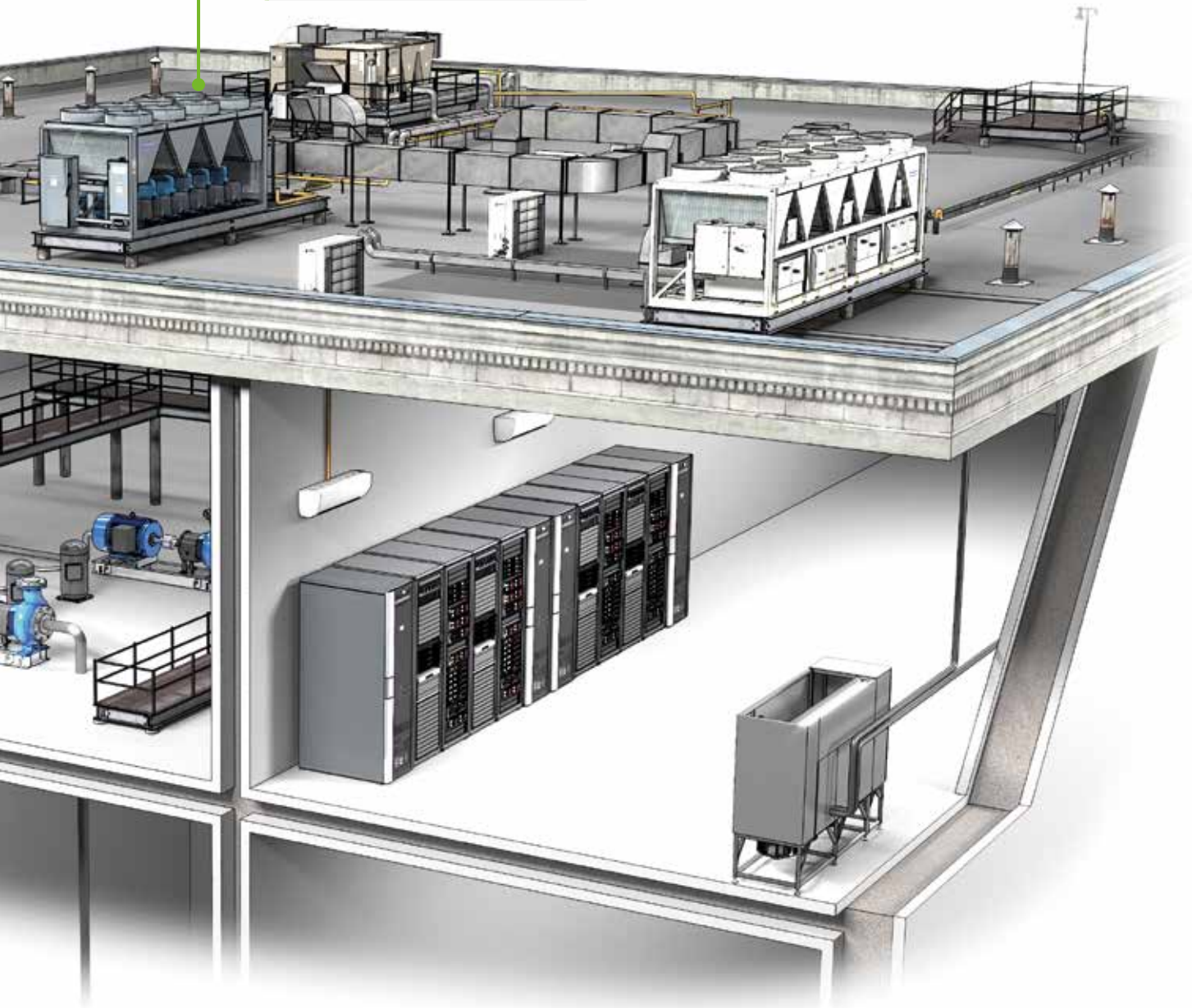

CASE STUDY: MEAT PROCESSING & PACKAGING

OEM achieves accuracy solution in less than three months for meat processing and packaging company.

A large, premium OEM customer chose Control Techniques as its partner to work on a crucial project increasing production, accuracy and throughput at a food and beverage manufacturer for meat processing and packaging machines.

Control Techniques has worked with this OEM for over 15 years and, in that time, has developed a very good working relationship, being the key supplier for the drives and motors in the machinery it makes for its customers. More than 80% of the drives and motors used by this OEM are supplied by Control Techniques. The working relationship has been built over many years to a point where Control Techniques totally understands the industry requirements of the OEM and its customers and has developed many solutions for them to date. A key factor to the success of the relationship is common development of technical solutions and the support that Control Techniques offer.



**Required accuracy
achieved**

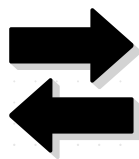

Improved throughput



Fast turnaround

The Challenge

Previously the OEM company produced only filling machines for their meat manufacturer; now they were challenged to supply a complete production line encompassing mincing, portioning, transporting and packaging.

The filling machine produces up to 300 portions of hamburgers per minute, transported via conveyor to a stacker where they are placed into stacks of six hamburgers top on each other. The finished goods then need to be secured before being transported to the packaging station.

The Solution

Working closely with the OEM, Control Techniques quickly found a solution for the new stacker machine that would synchronise six pairs of paddles to stack and secure the hamburgers. They are then transported via conveyor to the packing station where they are packed in trays ready for distribution.

The OEM needed an extremely dynamic solution to secure and stack 300 hamburgers per minute with an error rate of <1%.

Since the OEM is now producing the complete production line for its customer, the machines must be flexible and efficient in adapting to the needs of the end-user, in order to stack the exact number of hamburgers required by their customers at any one time.

The production line features Unidrive M as frequency controller, together with Unimotor HD motors. The real game-changer though is that the dynamic stacking process could be achieved without external PLC control. Control Techniques' solution was to create the required accuracy with an internal MCI210 module using the Ethernet bus, in combination with Unidrive M's onboard advanced motion controller (AMC). All status information about the system is displayed on a HMI via Modbus TCP.

The Benefits

Control Techniques once again excelled, by completing the entire project from conception, to design and testing all in less than three months.

The key factor for this OEM was the fast and efficient service they received from Control Techniques again on this project, giving them the confidence that future projects will be handled with the same speed, professionalism and efficiency.

DRIVE OBSESSED



Control Techniques has been designing and manufacturing the best variable speed drives in the world since 1973.

Our customers reward our commitment to building drives that outperform the market. They trust us to deliver on time every time with our trademark outstanding service.

More than 50 years later, we're still in pursuit of the best motor control, reliability and energy efficiency you can build into a drive. That's what we promise to deliver, today and always.

1.6K+

Employees

70

Countries

#1 FOR ADVANCED

MOTOR AND DRIVE TECHNOLOGY



Nidec Corporation is a global manufacturer of electric motors and drives.

Nidec was set up in 1973. The company made small precision AC motors and had four employees. Today, it's a global corporation that develops, builds and installs cutting-edge drives, motors and control systems in over 40 countries with a workforce of more than 114,000.

You'll find its innovations in thousands of industrial plants, IoT products, home appliances, cars, robotics, mobile phones, haptic devices, medical apparatus and IT equipment all over the world.

114K

Employees

\$17.4B

Group Turnover

40+

Countries

300+

Companies



CONTROL TECHNIQUES.
NO ONE KNOWS DRIVES LIKE WE DO.

Our drive obsessive representatives will drive you in the right direction and give you first class support whenever you need it.

For more information, or to find your local drive centre, visit:

www.controltechniques.com

Connect with us



©2024 Nidec Control Techniques Limited. The information contained in this brochure is for guidance only and does not form part of any contract. The accuracy cannot be guaranteed as Nidec Control Techniques Ltd have an ongoing process of development and reserve the right to change the specification of their products without notice.

Nidec Control Techniques Limited. Registered Office: The Gro, Newtown, Powys SY16 3BE.

Registered in England and Wales. Company Reg. No. 01236886.

0781-0305-03 01/24

