



OPTIONS & ACCESSORIES

For Unidrive SP, Digitax ST Mentor MP,
Quantum MP and Epsilon EP

CONTROL TECHNIQUES™

Nidec
All for dreams

Contents

Control Accessories

Operator Interfaces.....	3
Interconnect Components.....	7
CTNet Drive Network Components.....	12
Motion Synchronization Accessories.....	18
Logic and I/O Power Supplies.....	19

Power Accessories

Line and Load Reactors.....	20
Isolation Transformers.....	25
Input RFO Filters.....	26
Dynamic Braking Resistors.....	30

Operator Interfaces

Remote-Mount Drive Keypads

The following operator interfaces can be remote mounted from the drive and provide full drive parameter access. The keypads can be mounted up to 100 ft (30 m) from the drive.

SM-KEYPAD-PLUS and MP-KEYPAD



These keypads provide a back-lit LCD display with standard drive control pushbuttons plus a parameter help button. Multiple languages are supported including Spanish and French. Customized text is possible with optional text editing software. A browsing filter is built in for rapid viewing of your choice of up to 50 parameters.

Order Code	Display Type	Drives
SM-KEYPAD-PLUS	LCD, NEMA12 (IP54)	Unidrive SP, Digitax ST
MP-KEYPAD		Mentor MP, Quantum MP



Operator Interfaces

CTVue — Graphical Human Machine Interface

Control Techniques offers a complete range of HMI (Human Machine Interface) display panels. CTVue Configurator software is included and makes programming these HMIs quick and intuitive. The CTVue Configurator software includes built-in communication drivers and predefined drive parameters to speed integration with all Control Techniques drive lines. The broad hardware offering also ensures there is a CTVue HMI that balances price and functionality.

The 4.3-inch CTVue 304KE is designed for applications where available mounting space is at a premium. The smallest touchscreen in the CTVue family, just over 5 inches wide and 4 inches tall, the 304KE boasts a bright TFT (thin film transistor) display with full 32 K-color support.

For small and economical displays, the 303L and 303M and offer a 3.2-inch monochrome graphical LCD display. The 303L is the low-cost choice with one RS485 port. The 303M is full featured with one Ethernet, one RS485, two RS232, and one Compact Flash port.

For medium-size displays, the 306M/A and 308A graphical touchscreens provide larger screens for enhanced display of graphics. The 306 and 308 versions include Ethernet, one RS485, two RS232, and one Compact Flash port and are available with color or monochrome graphical display.

For large displays, the 310C and 315C graphical color touchscreens provide the most graphical display area while offering all the connectivity and features of the 306 and 308 series plus a USB host port and option for an additional Ethernet port. Super-bright NEMA 4X outdoor versions are also available - 303S, 306MS and 310S.

All of the CTVue HMIs, except the CTVue 304KE, have a Compact Flash port which allows for storage and transfer of data from a variety of external data sources using a standard Compact Flash card (order separately).



Key Features

- Integrated Control Techniques drivers
- Remote web and FTP access (except 304KE)
- Powerful protocol converter
- USB programming port (except 304KE)
- Alarming and data logging
- Bright TFT color display offerings
- Complimentary, simple-to-use, programming software
- Flexible Compact Flash slot (except 304KE)
- Security user levels/passwords
- Available front faceplate customization
- For use in hazardous locations
- 24 V operation

CTVUE-304KE



- 4.3-inch, 480 x 272, Graphic Touch, TFT, 32 K-color display
- Ethernet, RS485 and RS232 port
- 128 MB onboard flash memory

CTVUE-303L/M/S



- 3.2-inch, 128 x 64, LCD, monochrome display
- Ethernet (M), RS485 (L), outdoor version available (S)
- 8 x customizable function keys
- Compact Flash slot (M)(S)
- 4 MB non-volatile flash memory
- USB host port

CTVUE-306M/A/MS



- 5.7-inch, 320 x 240, Graphic Touch display
 - (M) LCD, monochrome
 - (A) TFT, 256-color
 - (MS) LCD, monochrome (with UV protection for outdoors)
- Ethernet, RS485 and RS232 port
- Compact Flash slot
- 4/8 MB non-volatile flash memory
- Four programmable soft keys
- USB host port

CTVUE-308A/E



- 8.4-inch, 640x480, Graphic Touch, TFT, 32K-color display
- Ethernet, RS485 and RS232 port
- Compact Flash slot
- 32 MB non-volatile flash memory
- Six programmable soft keys
- USB host port

CTVUE-310C / E / R / RE / S / SE



- 10.4-inch, 640 x 480 (C, E, S, SE), 800 x 600 (R, RE), Graphic Color Touch, TFT, 32 K-color display
- Ethernet, RS232, RS485 port
- Compact Flash slot
- 32 MB non-volatile flash memory
- Outdoor version available
- USB host port

CTVUE-315C/E

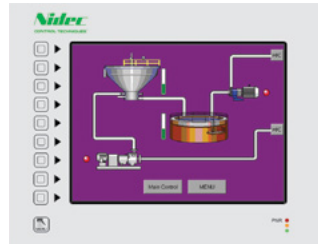

- 15-inch, 1024 x 768, Graphic Color Touch, TFT, 32 K-color display
- Ethernet, RS485, and RS232 port
- Compact Flash slot
- 64 MB non-volatile flash memory
- USB host port

When mounted using the supplied gasket, all panels have a rating of IP66 / NEMA 4X.

Order Code	Description	Dim. (in) HxWxD
CTVUE-304KE	4.3", 480 x 272, TFT, 32 K-color touchscreen - with RS232, RS485, Ethernet	4 x 5 x 1.5
CTVUE-303M	3.2", 128 x 64, LCD, monochrome display - with Ethernet, RS485, RS232, Compact Flash	5.9 x 7.5 x 2.1
CTVUE-306A	5.7", 320 x 240, TFT, 256-color touchscreen - with Ethernet, RS485, RS232	7.1 x 8.8 x 2.3
CTVUE-308A	8.4", 640 x 480, TFT, 32 K-color touchscreen - with (1) Ethernet, isolated comms RS485, RS232	8.2 x 10.3 x 2.2
CTVUE-310C	10.4", 640 x 480, TFT, 32 k-color touchscreen - with (1) Ethernet, isolated comms RS485, RS232	9.5 x 12.9 x 2.2
CTVUE-315C	15", 1024 x 768, TFT, 32 k-color touchscreen - with (1) Ethernet, RS485, RS232	13 x 16 x 2.8
CTVUE-CF1000	1 GB industrial Compact Flash memory	
CTVUE-CF2000	2 GB Industrial Compact Flash memory	
CTVUE-CONFIG-CD	Complimentary programming software CD	
CTVUE-USB	USB Programming cable PC to CTVue	
CTVUE-EP-485-xxx*	RS485 cable; RJ45 to RJ45	
UM-LCD-485-xxx*	RS485 cable for multidrop; RJ45 to RJ45	
CT-USB-CABLE	Modbus RTU (RS485) to USB conversion	
CTVUE-RS00	RS232 / RS485 communications option card	
CTVUE-CN00	CANopen communications option card	
CTVUE-PBDP	PROFIBUS DP communications option card	
CTVUE-DN00	DeviceNet communications option card	
CTVUE-PRO-4K	Serial Port cable for programming CTVUE-304KE	
CTVUE-ADK-485	DB9-pin connector to RJ45 adaptor (for use with CTVUE-EP-485 cables)	
CTVUE-USB-4K	USB to RS232 converter cable includes CTVUE-PRO-4K cable	

* Standard cable lengths: 5, 15, 25 ft (-005) (-015) (-025)

Operator Interfaces

CTVue Connectivity and Functionality

The CTVue touchscreens are easy to set up and connect to your application.

Connection to the Serial Port

The operator interface is connected directly to the RJ45 connection on the serial port. RS485 is a multi-drop protocol and may be connected to multiple drives if required.

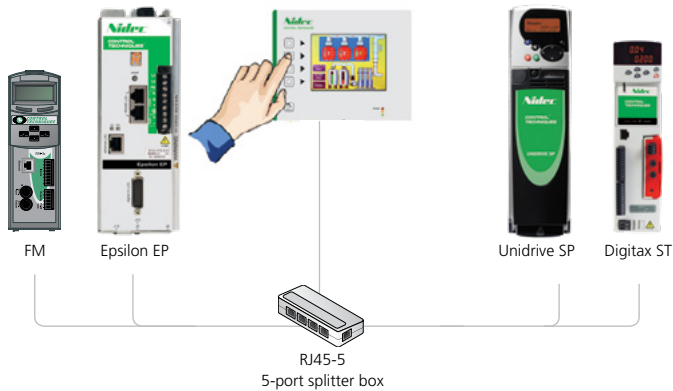

CT Vue Specifications	
Power Input	24 Vdc
Temperature	32 to 122 °F (0 to 50 °C)
Environmental	IP66 / NEMA 4X, for use in hazardous locations:*
	Class I, Division 2, Groups A,B,C and D
	Class II, Division 2, Groups F and G
Operating Humidity	80% relative maximum from 32 to 122 °F (0 to 50 °C)

*see website for individual data sheets

Connecting via Ethernet

The Epsilon EP-P, FM-3/4E and SM-ETHERNET option modules allow the operator interface to be connected to the drive using Modbus TCP/IP.

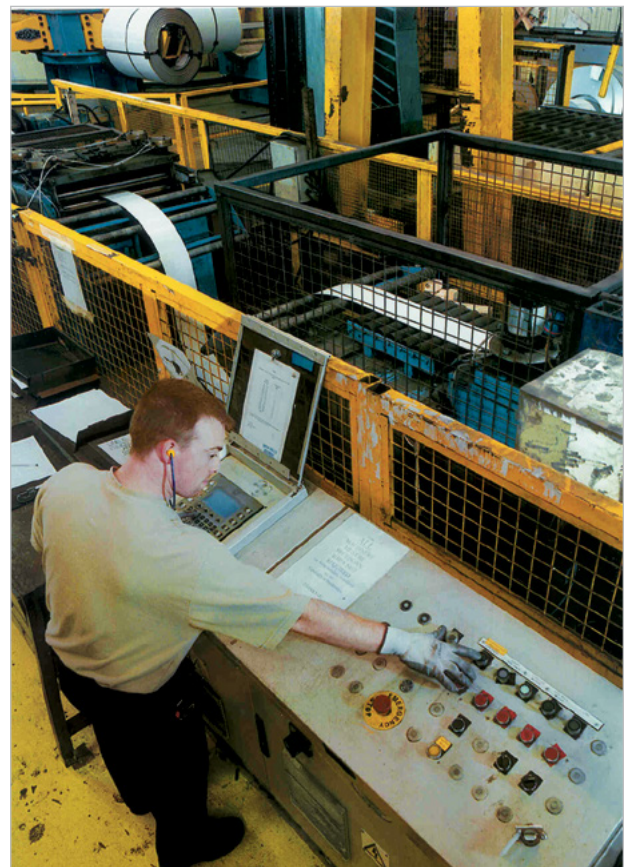
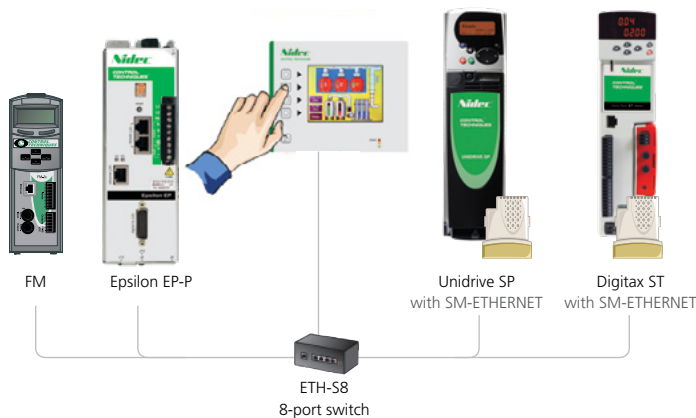

Operator Interface Single-drop Cables

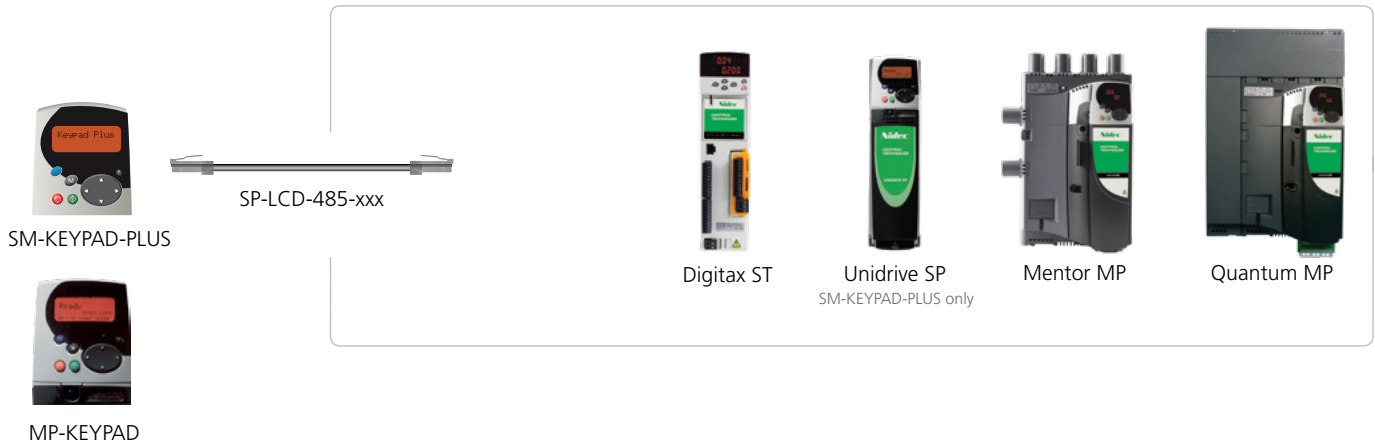
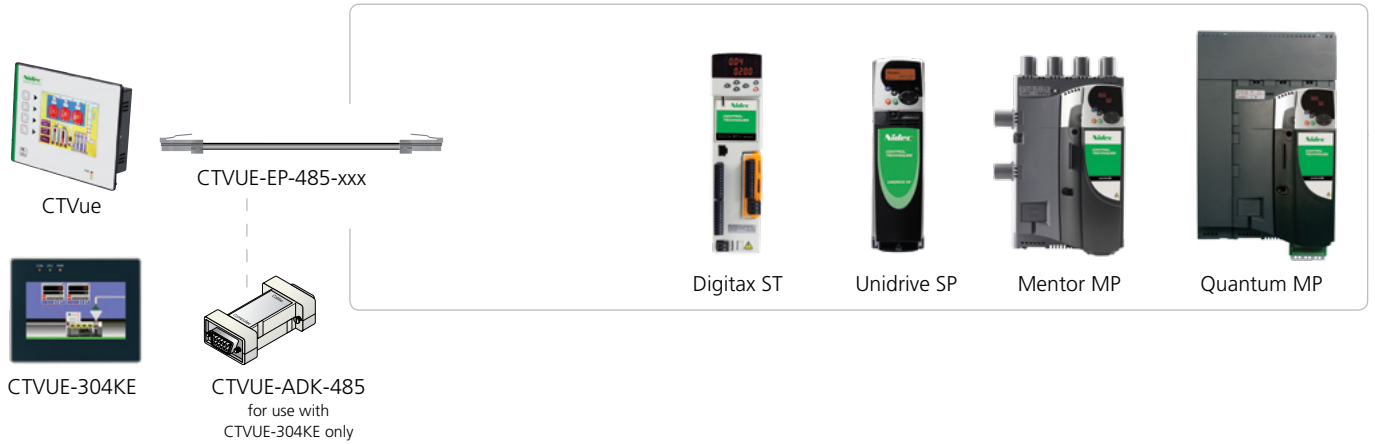

CTVUE-EP-485-xxx
RS485 cable; RJ45 to RJ45



CTVUE-ADK-485
RS485 DB9pin to RJ45 adaptor is used with the CTVUE-304KE
and appropriate drive RS485 cable

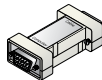

xxx = length in feet

SP-LCD-485-xxx
RS485 cable with RJ45 connector on both ends
for LCD Keypad and Unidrive SP



Interconnect Components

Operator Interface Multi-drop Cables

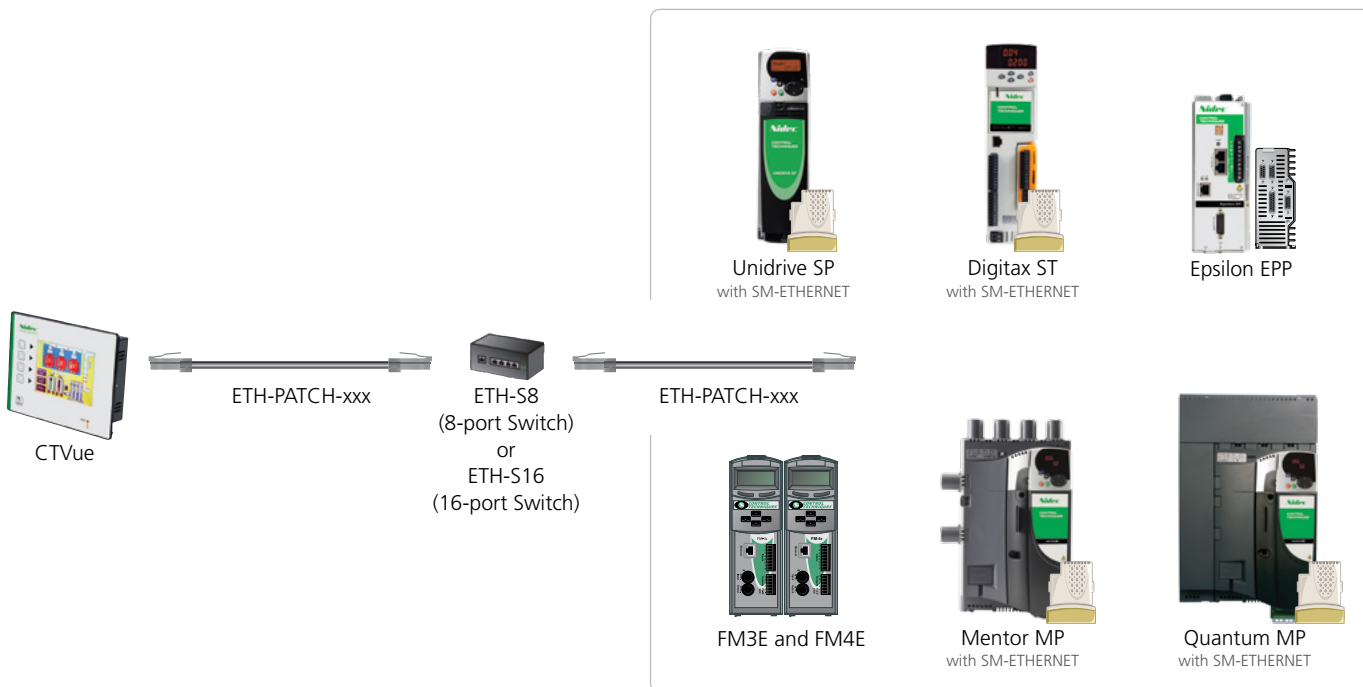
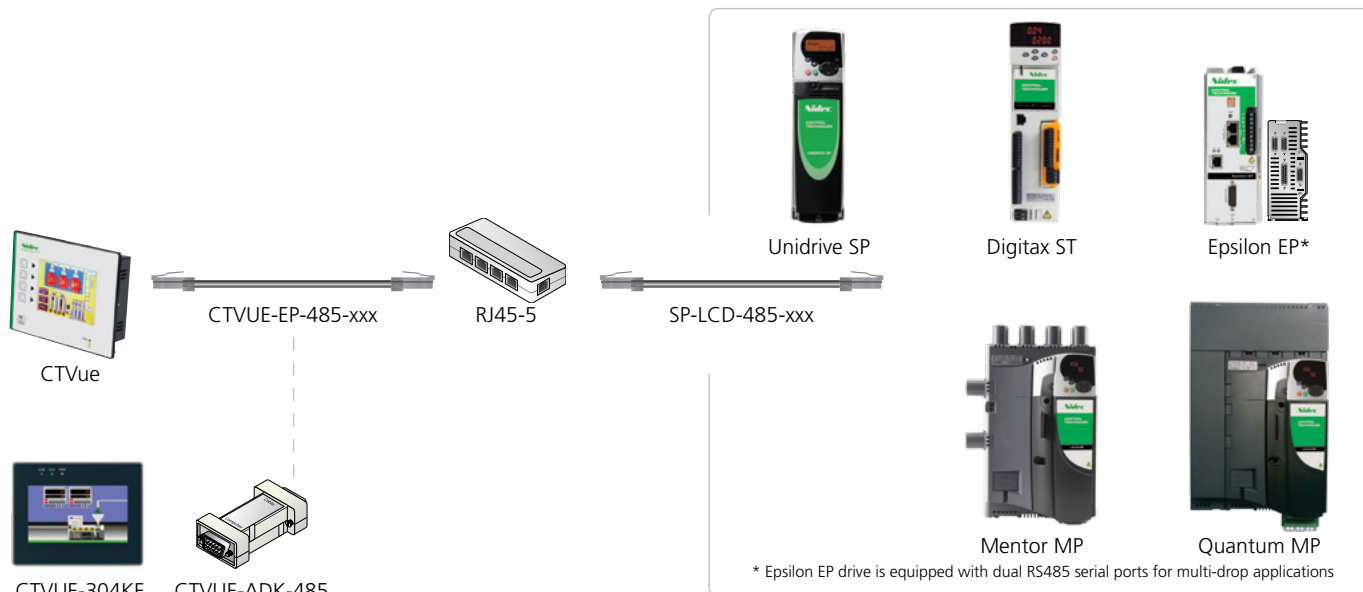

CTVUE-EP-485-xxx
RS485 cable; RJ45 to RJ45

SP-LCD-485-xxx
RS485 cable for multidrop; RJ45 connector on both ends

ETH-PATCH-xxx
RS485 multidrop cable; wires dressed at both ends

xxx = length in feet

Operator Interface Software Cables

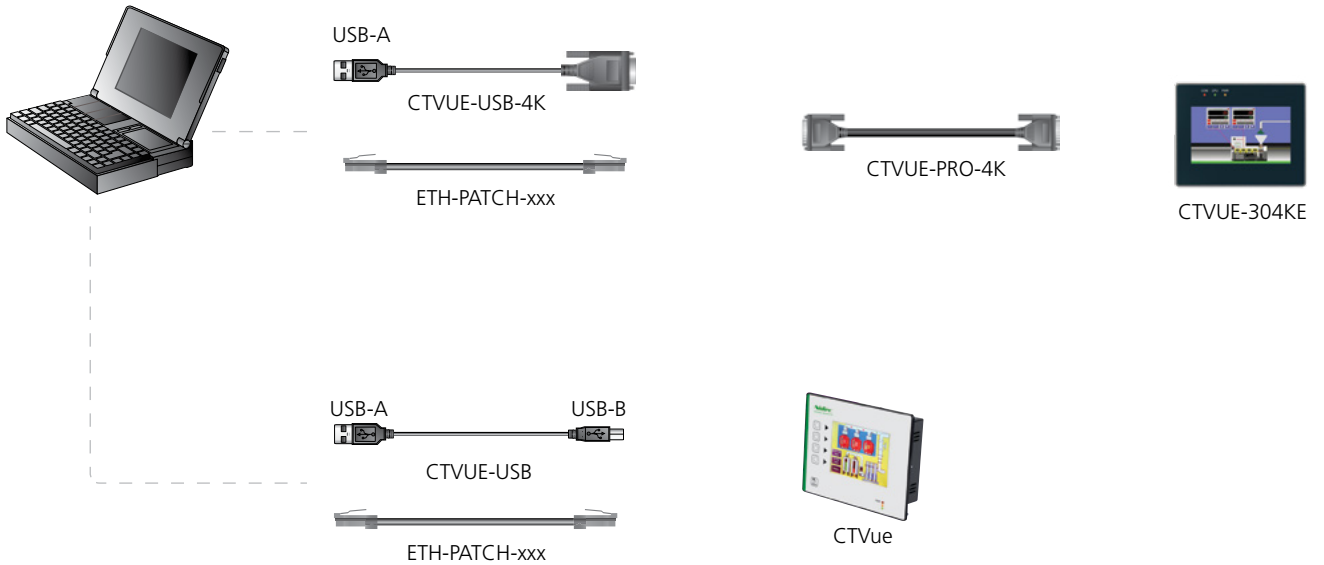

CT-USB-CABLE

Connects the Modbus port on the drive (RS485) directly to the USB port on your PC; USB to RS485 conversion



RJ45-5

RJ45 Splitter; accepts one RJ45 connector of input and 4 RJ45 connectors for output

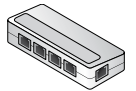

CTVUE-USB

CTVue USB programming cable: USB Connectors on both ends; USB-A on drive side and USB-B on panel side



CTVUE-USB-4K

USB to RS232 converter for programming CTVUE-304KE; this order code includes CTVUE-PRO-4K cable



SP-LCD-485-xxx

RS485 cable for multidrop: RJ45 connector on both ends

xxx = length in feet



CTVUE-PRO-4K



Serial port cable for convenient connection to CTVUE-304KE to PC.

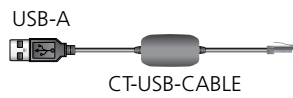

Interconnect Components

Software Interface Single-drop Cables



 Epsilon EP PowerTools Pro	 Digitax ST	
 Unidrive SP CTSoft CTScope SyPTLite SyPTPro	 Mentor MP CTSoft CTScope SyPTLite SyPTPro	 Quantum MP CTSoft CTScope SyPTLite SyPTPro



Software Interface Multi-drop Cables

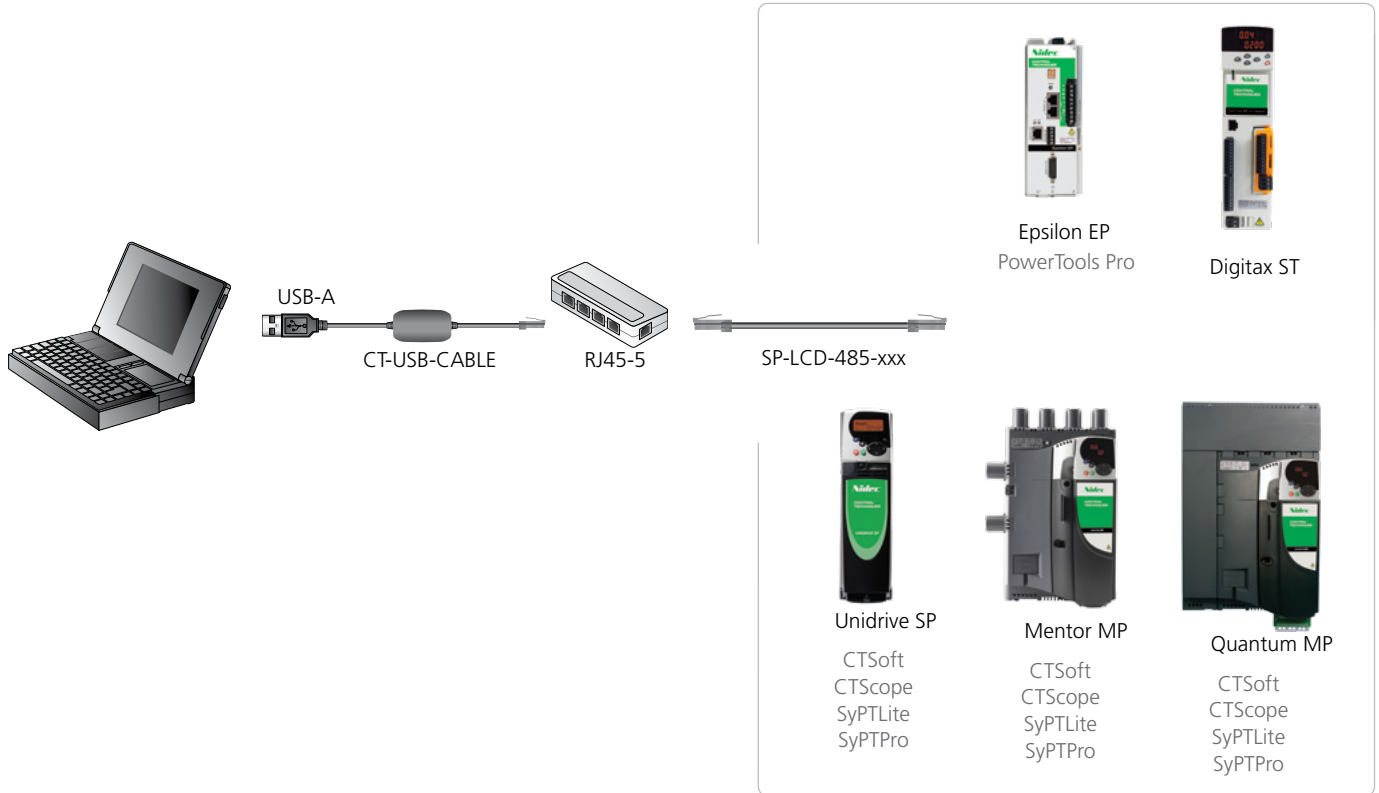

Drive Integration with CNet

Deterministic Distributed Control

The CNet interface enables users to leverage the capabilities of the Unidrive SP, Digitax ST-P, Mentor MP and Quantum MP applications coprocessor modules, for real-time decentralized control. CNet was developed specifically for highly dynamic applications, over trunk lengths generally exceeding 300 ft, using proven Token Ring data link technology. CNet is a “decentralized peer-to-peer” system (requiring no master PLC controller) with each intelligent node taking its turn to control the network and communicate directly, and in real-time, with other network nodes at data transfer rates of up to 5 Mbits/sec. CNet supports up to 255 nodes and provides an intelligent drive-oriented approach to systems integration based on decentralized control, universal communications and graphical software.

The Unidrive SP, Mentor MP, Quantum MP and Digitax ST-P drives provide a gateway to industrial networks such as PROFIBUS DP, Interbus-S, DeviceNet, Ethernet (EtherNet/IP, PROFINET RT, EtherCAT) and SERCOS using CNet.

Drive	Option Modules	
Unidrive SP	SM-APPS-PLUS	SM-REGISTER
Mentor MP		
Quantum MP		
Digitax ST-P	Integrated	

Decentralized Drives Control Solution

CNet is a comprehensive line of equipment enabling the design engineer to create high-performance and cost-effective decentralized drives control solutions.

CNet fieldbus is a 5 Mbit Token Ring network that supports peer-to-peer communications. Utilizing the field-proven ANSI/ATA 878.1 ARCNET standard as a foundation, CNet includes a custom protocol stack that supports cyclic data and non-cyclic “one-shot” transactions. The CNet fieldbus employs a transformer-isolated physical layer to allow use of a convenient, easy-to-install, two-wire shielded, non-polarized cable.

Cyclic data exchanges are pre-programmed block transfers (20 x 32 bit registers max.) between coprocessors.

Non-cyclic exchanges are asynchronous transfers initiated by application programs, SCADA / HMI devices and PCs using an OPC server.

CNet networks are configured using SyPTPro software. Simple networks can be configured via the drive keypad or with CTSOft drive configuration software.



CNet Integration At-a-Glance

Function	Description	Order Code
Application Coprocessor Modules	Includes CNet fieldbus connections and coprocessor	SM-APPS-PLUS SM-REGISTER
Network Accessories	3-port hub, provides connectivity to 3 CNet segments	CTNET-HUB-REVD
	Fiber optic repeater	CTNET-FIB-REVD
	3-port hybrid hub, for connectivity between current and previous CNet versions	CTNET-HYBRID-HUB
	CNet bulk cable	CTNET-xxx*
PC Network Card	USB22-CNet — computer USB port to CNet communications interface	4500-0100
CNet I/O	Bus coupler	SSP7200-REVD
Application Programming Software	Systems programming toolkit	SYPTPRO

* Cable available in standard lengths of 100 m, 200 m or custom lengths up to 200m



Application Coprocessor Platforms

SM-APPS-PLUS & SM-REGISTER

Option Modules

SM-APPS-PLUS and SM-REGISTER click-in coprocessors include CTNet high-speed peer-to-peer fieldbus connectivity.

These CTNet-equipped coprocessors are based on a high-performance microprocessor with up to 384 KB of program storage and 80KB of variable storage for user applications. In addition to the CTNet fieldbus, serial ports are available for RS485 communications. The coprocessors also include a built-in counter-timer unit and position controller capability.

The Digitax ST-P and Digitax ST-I servo drives include a built-in coprocessor with the same functionality as the SM-APPS-PLUS and SM-APPS-LITE-V2 option modules respectively.



SM-APPS-PLUS
Unidrive SP, Mentor MP, Quantum MP



SM-REGISTER
Unidrive SP, Mentor MP, Quantum MP



Network Accessories

Repeaters

For extending CTNet cable segments and creating star topologies, there are three types of repeaters available (see At-a-Glance table on previous page).



CTNet Cable

Control Techniques stocks a high-quality shielded twisted-pair cable suitable for high-speed data transmission.



PC Network Interface Card

For desktop and laptop computers, use the USB22-CTNet network card. This interface card provides direct access to all of the drive and I/O modes in a system.



CTNet I/O

A high-quality modular I/O system is available for CTNet systems. Remote systems for CTNet include a bus coupler and a large variety of click-on terminal blocks allowing up to 256 digital inputs or outputs and up to 100 analog inputs and outputs per bus coupler. Up to 64 remote I/O systems can be attached to a CTNet network. I/O points can be easily read or written.



The range of CTNet I/O options include:

- Digital input terminals in 5, 24, and 48 Vdc, 120 Vac
- Digital output terminals 5 and 24 Vdc, Relay Output (115-400 Vac)
- Analog input and output terminals for a wide array of applications. All standard voltages, mA, RTD, thermocouple, etc.

CTNet

CTNet Software

Order Code	Description
SYTPRO	Coprocessor module programming and CTNet system configuration tool; software registration required
CTNET API	CTNet software driver for Windows® DLL (included with SYTPro)
CTNET OPC	CTNet software driver for Microsoft® OPC

CTNet Hardware

Order Code	Description
PS5R-B24	24 Vdc power supply, 600 mA max output current, 100 to 240 Vac input power
CTNET-100	CTNet bulk cable, 325 ft (100 m) length
CTNET-200	CTNet bulk cable, 650 ft (200 m) length
CTNET-xxx	CTNet bulk cable, custom length in 10 ft increments (max 650 ft)

CTNet Hardware

Order Code	Description
4500-0100	USB22-CTNet; computer USB port to CTNet communications interface
CTNET-FIB-REVD	Twisted-pair to fiber optic repeater for CTNet cable requirements greater than 200 m
CTNET-HUB-REVD	CTNet 3-port hub, provides connectivity up to 3 CTNet segments (current CTNet version only)
CTNET-PCI-REVD	CTNet interface card with PCI bus for desktop PC's; RoHS

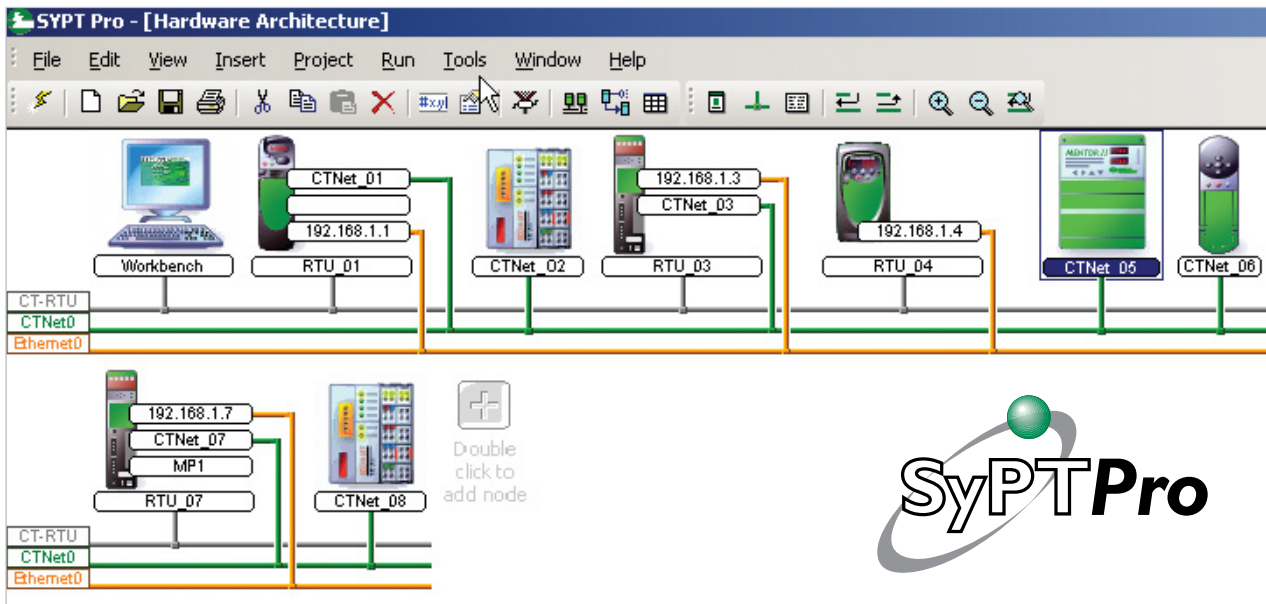

CTNet I/O

CTNet I/O Bus Couplers

Order Code	Description
SSP7200-REVD	CTNet I/O bus coupler, CTNet revision D hardware
SSP9010	Bus-end terminal for termination on CTNet I/O assembly



CTNet I/O Digital Input Terminals

Order Code	Description
SSP1002	2-Digital input terminal, 24 Vdc, 3.0 ms input filter
SSP1012	2-Digital input terminal, 24 Vdc, 0.2 ms input filter
SSP1032	2-Digital input terminal, 48 Vdc, 3.0 ms input filter
SSP1052	2-Digital input terminal, 24 Vdc, positive or negative switching, 3.0 ms input filter
SSP1104	4-Digital input terminal, 24 Vdc, 3.0 ms input filter
SSP1114	4-Digital input terminal, 24 Vdc, 0.2 ms input filter
SSP1124	4-Digital input terminal, 5 Vdc, 0.2 ms input filter
SSP1154	4-Digital input terminal, 24 Vdc, positive or negative switching, 3.0 ms input filter
SSP1164	4-Digital input terminal, 24 Vdc, positive or negative switching, 0.2 ms input filter
SSP1184	4-Digital input terminal, 24 Vdc, negative switching, 3 ms input filter
SSP1408	8-Digital input terminal, 24 Vdc, 3.0 ms input filter, single conductor
SSP1702	2-Digital input terminal, 120/230 Vac
SSP1722	2-Digital input terminal, 120/230 Vac w/o power contacts
SSM1002-0004	16-Digital input terminal, 24 Vdc
SSM1004-0004	32-Digital input terminal, 24 Vdc
SSM1008-0004	64-Digital input terminal, 24 Vdc

CTNet I/O Digital Output Terminals

Order Code	Description
SSP2012	2-Digital output terminal, 24 Vdc, 0.5 A output
SSP2032	2-Digital output terminal, 24 Vdc, 0.5 A output, Reverse Polarity Protection
SSP2022	2-Digital output terminal, 24 Vdc, 2.0 A output
SSP2114	4-Digital output terminal, 24 Vdc, 0.5 A output
SSP2134	4-Digital output terminal, 24 Vdc, 0.5 A output, reverse polarity protection
SSP2184	4-Digital output terminal, 24 Vdc, 4 negative switching outputs, 0.5 A output
SSP2408	8-Digital output terminal, 24 Vdc, total current 3 A output, single-conductor connection
SSP2124	4-Digital output terminal, 5 Vdc, 20 mA output
SSP2702	2-Solid state outputs, normally open, 230 Vac, 0.3 A output
SSP2612	2-Relay outputs, isolated changeover contacts, 125 Vac, 2.0 A
SSP2622	2-Relay outputs, isolated normally open, 230 Vac, 2.0 A
SSP2602	2-Relay outputs, normally open to common power contacts, 230 Vac, 2.0 A
SSP2631	1-Relay output, normally open to power contact, 400 Vac, 3.75 A
SSM2002-0004	16-Digital output terminal, 24 Vdc

CTNet I/O

CTNet I/O Analog Input Terminals

Order Code	Description
SSP3002	2-Channel analog input terminal, -10 V to +10 V, 12 bit
SSP3102	2-Channel analog input terminal, -10 V to +10 V, 16 bit
SSP3408	8-Channel analog input terminal, -10 V to +10 V differential, 12 bit
SSP3062	2-Channel analog input terminal, 0 to 10 V single ended, 12 bit, power supply via the K-Bus
SSP3064	4-Channel analog input terminal, 0 to 10 V single ended, 12 bit, power supply via the K-Bus
SSP3468	8-Channel analog input terminal, 0 to 10 V single ended, 12 bit
SSP3012	2-Channel analog input terminal, 0 to 20 mA, 12 bit
SSP3448	8-Channel analog input terminal, 0 to 20 mA differential, 12 bit
SSP3112	2-Channel analog input terminal, 0 to 20 mA, 16 bit
SSP3042	2-Channel loop-powered input terminal, 0 to 20 mA, 12 bit, 24 Vdc power supply via the power contacts
SSP3022	2-Channel analog input terminal, 4 to 20 mA, 12 bit
SSP3052	2-Channel loop-powered input terminal, 4 to 20 mA, 12 bit, 24 Vdc power supply via the power contacts
SSP3458	8-Channel analog input terminal, 4 to 20 mA differential, 12 bit
SSP3202	2-Channel PT100 (RTD) input terminal, 16 bit, preset to PT100, power supply via K-Bus
SSP3312	2-Channel thermocouple input terminal, 16 bit, preset to type K, open-circuit recognition

CTNet I/O Analog Output Terminals

Order Code	Description
SSP4002	2-Channel analog output terminal, 0 to 10 V, 12 bit
SSP4408	8-Channel analog output terminal, 0 to 10 V, 12 bit
SSP4032	2-Channel analog output terminal, -10 V to +10 V, 12 bit
SSP4132	2-Channel analog output terminal, -10 V to +10 V, 16 bit
SSP4438	8-Channel analog output terminal, -10 V to +10 V, 12 bit
SSP4012	2-Channel analog output terminal, 0 to 20 mA, 12 bit, 24 Vdc via the power contacts
SSP4112	2-Channel analog output terminal, 0 to 20 mA, 16 bit
SSP4418	8-Channel analog output terminal, 0 to 20 mA, 12 bit
SSP4022	2-Channel analog output terminal, 4 to 20 mA, 12 bit, 24 Vdc via the power contacts
SSP4428	8-Channel analog output terminal, 4 to 20 mA, 12 bit



CTNet I/O

CTNet System Terminals

Order Code	Description
SSP9080	Isolation terminal
SSP9100	Power supply terminal, 24 Vdc
SSP9110	Power supply terminal with diagnostics, 24 Vdc
SSP9150	Power supply terminal, 230 Vac
SSP9160	Power supply terminal with diagnostics, 230 Vac
SSP9180	Potential distribution terminal with 2 clamps per power contact
SSP9185	Potential distribution terminal with 4 clamps per power contact
SSP9190	Power supply terminal
SSP9195	Shield terminal, potential distribution terminal with connection to earth
SSP9200	Power supply terminal, 24 Vdc with fuse
SSP9210	Voltage supply terminal, 24 Vdc with fuse and diagnostics
SSP9250	Voltage supply terminal, 230 Vac with fuse
SSP9260	Voltage supply terminal, 230 Vac with fuse and diagnostics
SSP9400	Power supply unit terminal for the K-Bus, 24 Vdc, 2 A for the K-bus supply
SSP9505	Power supply unit terminal, 24 Vdc input, 5 Vdc - 1 A output
SSP9510	Power supply unit terminal, 24 Vdc input, 10 Vdc - 0.5 A output
SSP9515	Power supply unit terminal, 24 Vdc input, 15 Vdc - 0.5 A output



Motion Synchronization Components

Control Technique's hardware provides easy configuration of motion synchronization. Pre-configured cables are available for connection from a master synchronization encoder to drive connections. Each servo drive family is equipped with a buffered encoder output connection. The Epsilon EP drive comes standard with incremental encoder synchronization input and output connections. The Digitax ST and Unidrive SP use the SM-UNI-ENCODER option module which allows the use of several compatible feedback devices supporting incremental, SinCos, HIPERFACE® (SICK), EnDAT and SSI encoders.

Using the preconfigured cables, 1.5-axis synchronization is easily achieved.

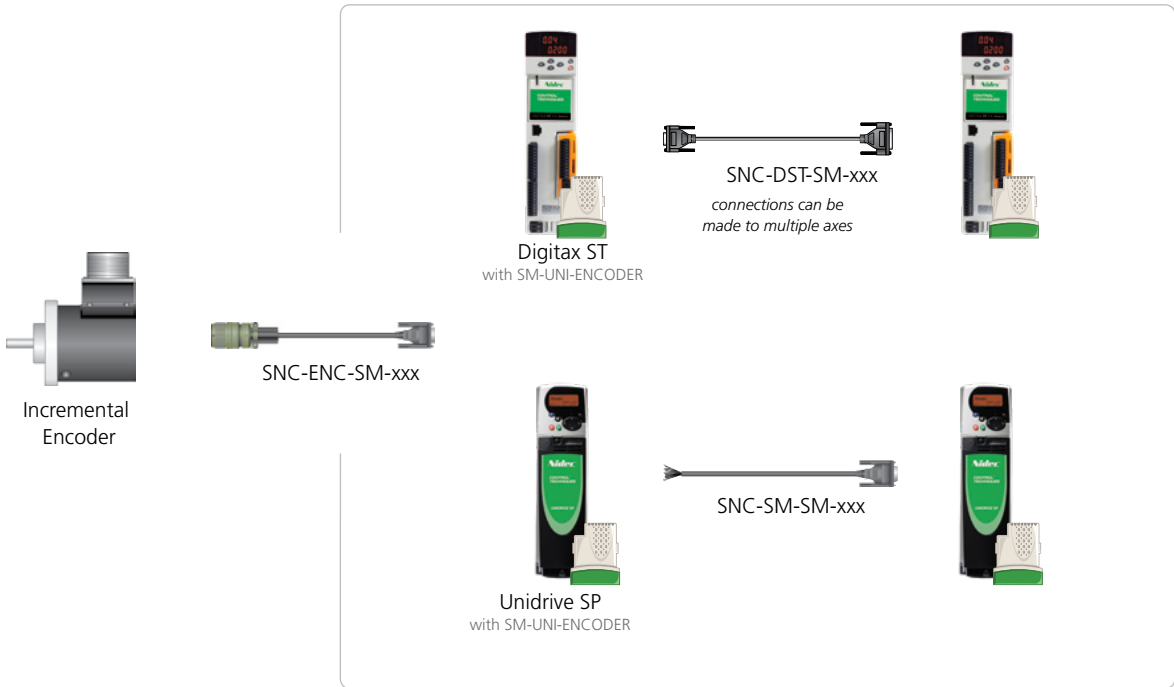
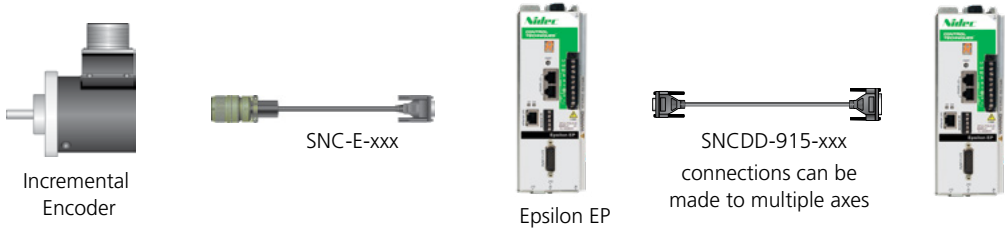

SNCE-xxx -015, -025, -050
Sync cable to SNCI, Encoder connector to D9P connector
SCSLD to SNCI, or Epsilon EP Sync In

SNCDD-915-xxx -001, -005, -010, -025
Drive Sync Out to Drive Sync In cable Epsilon EP to Epsilon EP

SNC-ENC-SM -010, -025, -050
Sync cable to SM-UNI-ENCODER, Encoder connector to D15P connector
SCSLD to SM-UNI-ENCODER

SNC-DST-SM-xxx -002, -005, -010
Drive Encoder Output to SM-UNI-ENCODER Input Digitax ST
SNC-SM-SM-xxx

xxx = length in feet

SM-UNI-ENCODER output to SM-UNI-ENCODER,
DB15 connector on one end, flying leads on the other

Encoder Order Codes

Description	Side Connection Order Code	End Connection Order Code
Synchronization Encoder 3000 Line (12000 ppr Quadrature)	SCSLD-4R	SCSLD-4
Synchronization Encoder 2500 Line (10000 ppr Quadrature)	SCSLD-3R	SCSLD-3
Synchronization Encoder 1000 Line (4000 ppr Quadrature)	SCSLD-2R	SCSLD-2

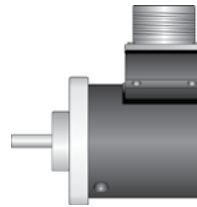

Side Connector



End Connector

Encoder Breakout Boards

STI-ENC

Encoder feedback connector (J6) breakout board (HD-DB15) *Epsilon EP*

SM-ENC

Encoder feedback connector breakout board (DB15) Digitax ST - B, Z, P, I *Unidrive SP*

Encoder Specifications

Supply Voltage	+5 Vdc
Current	Line drives with ZR=+5 Vdc @ 5 mA
Frequency	Up to 200 kHz
Outputs	Analog - differential peak-to-peak amplitude of 2.5 Vdc
Operating Temp.	32 to 158 °F (0 to 70 °C)

*see website for individual data sheets

Additional Cables for Alternative Connections

SNCFLI-xxx  -005, -010, -015, -025
Drive Sync In cable *Epsilon EP, STI-SNCOA Breakout Board*

SNCFLOA-xxx  -005, -010, -015, -025, -050
Drive Sync Out cable to Flying Leads
Epsilon EP

STI-SNCOA
Drive Sync Out and Analog In/Out Breakout Board;
DB15 *Epsilon EP*



STI-SNCI
Drive Sync In Breakout Board;
DB9S *Epsilon EP*



Logic and I/O Power Supplies

MLP-002-00
2.1 Amp, +24 Vdc, universal input
90 to 264 Vac
Epsilon, MDS

MLP-005-00
5 Amp, +24 Vdc, universal input
90 to 264 Vac
Epsilon, MDS, Unidrive SP size 6

MLP-010-00
10 Amp, +24 Vdc, universal input
90 to 264 Vac
Epsilon, MDS, Unidrive SP size 6



xxx = length in feet

Line and Load Reactors

Line and Load Reactors

Line reactors (sometimes called “line chokes”) are a common power accessory for electronic variable speed drives. These components add an extra margin of protection for AC and DC drives from supply transients.

Line reactors are strongly recommended for installation with AC drives that do not have built-in inductors. Refer to the built-in inductor columns in the following tables.

Load reactors are used on the output of AC drives to reduce the effects of high motor wiring capacitance and to “soften” the dV/dt (rate of change of voltage) applied to the motor windings.

Reactors in AC drive applications:

- Help reduce harmonic distortion of the input line current
- Improve input line current balance
- Reduce nuisance drive over-voltage trips caused by transient voltage spikes and power line notches
- Protect input rectifiers from in-rush current caused by sudden power line surges and sags
- Extend the life of the DC bus capacitor bank by reducing the internal heating caused by ripple current
- Protect motor windings from long lead effects when used on the drive output

Line Reactors in DC drive applications:

- Minimize crosstalk between multiple SCR drives by reducing line notching and subsequent dV/dt misfiring and /or bridge failures
- Eliminate SCR failures caused by high dV/dt levels associated with stiff or power factor corrected power lines
- Protect other line-powered sensitive electronic equipment by filtering electrical noise and/or interference caused by drives on the power line

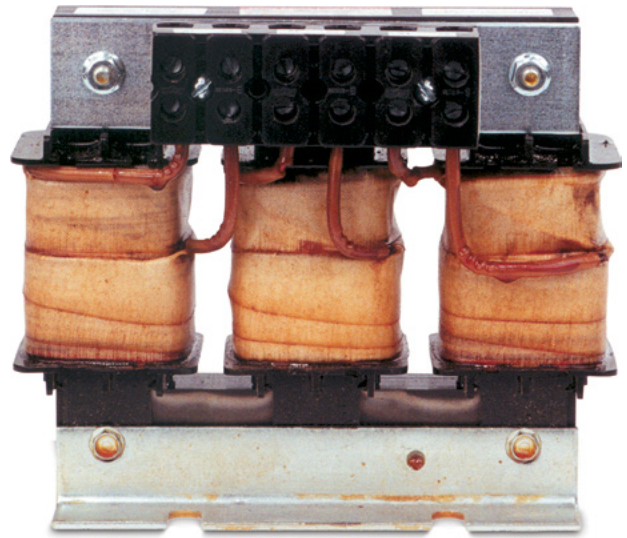

Line and Load Reactor Specifications	
Voltage	690 Vac maximum
Ambient Temperature	104 °F (40 °C)
Overload	200% for 10 seconds 150% for 1 minute
Approvals	CE UL508 CSA C22.2

Order Code

xx - x - xxxxA - x

LR = Line Reactor

L = Low Impedance
M = Medium Impedance
H = High Impedance

Current Rating

A = Line Reactor
Blank = Load Reactor

C = Open Chassis
E = Enclosed NEMA 1



AC Drive Line and Load Reactors

115/230 Vac

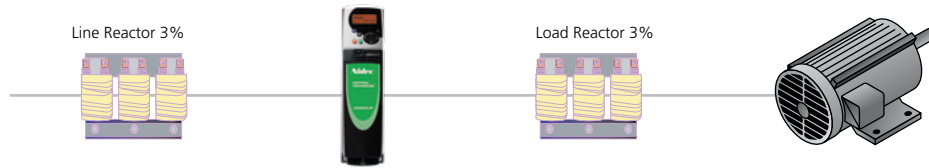

Drive Order Code	Motor Power (HP)	Built-in Inductor	Input Line Reactor Order Code	Current (A)	Output Load Reactor Order Code	Current (A)
230 Vac 1Ø Supply, 230 Vac 3Ø Output						
SP0201	0.5	No	4402-0224	6.5	LRL0004-X	4
SP0202	0.75	No	4402-0225	15.1	LRL0004-X	4
SP0203	1	No	4402-0225	15.1	LRL0004-X	4
SP0204	1.5	No	4402-0225	15.1	LRL0008-X	8
SP0205	2	No	4402-0226	26.2	LRL0008-X	8
230 Vac 3Ø Supply and Output						
SP0201	0.5	No	LRL003A4-X	3.4	LRL0004-X	4
SP0202	0.75	No	LRL004A8-X	4.8	LRL0004-X	4
SP0203	1	No	LRL007A6-X	7.6	LRL0004-X	4
SP0204	1.5	No	LRL0011A-X	11	LRL0008-X	8
SP0205	2	No	LRL0011A-X	11	LRL0008-X	8
SP1201	1.5	No	LRL007A6-X	7.6	LRL0008-X	8
SP1202	2	No	LRL0011A-X	11	LRL0008-X	8
SP1203	3	No	LRL0014A-X	14	LRL0012-X	12
SP1204	3	No	LRL0021A-X	21	LRL0012-X	12
SP2201	5	Yes	LRL0014A-X	14	LRL0018-X	18
SP2202	7.5	Yes	LRL0021A-X	21	LRL0025-X	18
SP2203	10	Yes	LRL0028A-X	28	LRL0035-X	18
SP3201	15	Yes	LRL0046A-X	46	LRL0045-X	18
SP3202	20	Yes	LRL0055A-X	55	LRL0055-X	18
SP4201	25	Yes	LRL0065A-X	65	LRL0080-X	18
SP4202	30	Yes	LRL0083A-X	83	LRL0100-X	18
SP4203	40	Yes	LRL0104A-X	104	LRL0130-X	18
SP5201	50	Yes	LRL0130A-X	130	LRL0160-X	18
SP5202	60	Yes	LRL0160A-X	160	LRL0160-X	18

AC Drive Line and Load Reactors

460 Vac

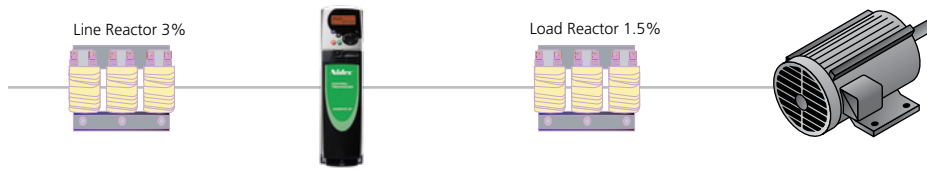

Drive Order Code	Motor Power (HP)	Built-in Inductor	Input Line Reactor Order Code	Current (A)	Output Load Reactor Order Code	Current (A)
SP0401	0.5	No	LRM002A1-X	21	LRL0002-X	2
SP0402	0.75	No	LRM003A4-X	3.4	LRL0002-X	2
SP0403	1	No	LRM003A4-X	3.4	LRM0004-X	4
SP0404	1.5	No	LRM004A8-X	4.8	LRL0004-X	4
SP0405	2	No	LRM007A6-X	7.6	LRM0008-X	8
SP1401	1.5	No	LRM004A8-X	4.8	LRL0004-X	4
SP1402	2	No	LRM007A6-X	7.6	LRL0004-X	4
SP1403	3	No	LRM007A6-X	7.6	LRM0008-X	8
SP1404	5	No	LRM0011A-X	11	LRL0008-X	8
SP1405	5	Yes	LRM0011A-X	11	LRL0012-X	12
SP1406	7.5	Yes	LRM0014A-X	14	LRL0012-X	12
SP2401	10	Yes	LRM0021A-X	21	LRL0018-X	18
SP2402	15	Yes	LRM0021A-X	21	LRL0025-X	25
SP2403	20	Yes	LRM0035A-X	35	LRL0035-X	35
SP2404	20	Yes	LRM0035A-X	35	LRL0035-X	35
SP3401	25	Yes	LRM0035A-X	35	LRL0035-X	35
SP3402	30	Yes	LRM0046A-X	46	LRL0045-X	45
SP3403	40	Yes	LRM0055A-X	55	LRL0080-X	80
SP4401	50	Yes	LRM0065A-X	65	LRL0080-X	80
SP4402	60	Yes	LRM0083A-X	83	LRL0100-X	100
SP4403	75	Yes	LRM0104A-X	104	LRL0130-X	130
SP5401	100	Yes	LRM0130A-X	130	LRL0160-X	160
SP5402	150	Yes	LRM0160A-X	160	LRL0200-X	200
SP6401	150	Yes	LRM0250A-X	250	LRL0250-X	250
SP6402	200	Yes	LRM0250A-X	250	LRL0250-X	250

AC Drive Line and Load Reactors

575/690 Vac

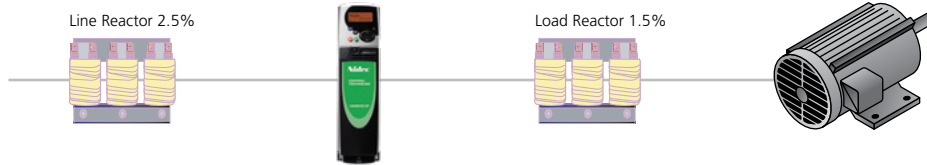

Drive Order Code	Motor Power (HP)	Built-in Inductor	Input Line Reactor Order Code	Current (A)	Output Load Reactor Order Code	Current (A)
575 Vac 3Ø						
SP3501	5	Yes	LRH007A6-X	7.6	LRM0008-X	8
SP3502	5	Yes	LRH007A6-X	7.6	LRM0008-X	8
SP3503	7.5	Yes	LRH0011A-X	11	LRL0012-X	12
SP3504	10	Yes	LRH0011A-X	11	LRL0012-X	12
SP3505	15	Yes	LRH0021A-X	21	LRL0018-X	18
SP3506	20	Yes	LRH0028A-X	28	LRL0025-X	25
SP3507	25	Yes	LRM0028A-X	28	LRL0035-X	35
SP4603	30	Yes	LRM0035A-X	35	LRL0045-X	45
SP4604	40	Yes	LRM0046A-X	46	LRL0045-X	45
SP4605	50	Yes	LRM0055A-X	55	LRL0055-X	55
SP4606	60	Yes	LRM0065A-X	65	LRL0080-X	80
SP5601	75	Yes	LRM0083A-X	83	LRL0100-X	100
SP5602	100	Yes	LRM0104A-X	104	LRL0100-X	100
SP6601	125	Yes	LRM0130A-X	130	LRL0130-X	130
SP6602	150	Yes	LRM0160A-X	160	LRL0160-X	160
690 Vac 3Ø						
SP4601	25	Yes	LRH0028A-X	28	LRM0025-X	25
SP4602	30	Yes	LRH0028A-X	28	LRM0035-X	35
SP4603	40	Yes	LRM0035A-X	35	LRM0045-X	45
SP4604	50	Yes	LRM0046A-X	46	LRL0045-X	45
SP4605	60	Yes	LRM0055A-X	55	LRL0055-X	55
SP4606	75	Yes	LRM0065A-X	65	LRL0080-X	80
SP5601	100	Yes	LRM0083A-X	83	LRL0100-X	100
SP5602	125	Yes	LRM0104A-X	104	LRL0100-X	100
SP6601	150	Yes	LRM0130A-X	130	LRL0130-X	130
SP6602	175	Yes	LRM0160A-X	160	LRM0160-X	160

NOTE: Average % impedance is indicated in the graphics for each voltage rating. Consult factory for different % impedance requirements and NEMA 3R outdoor enclosure option.

DC Drive Line Reactors

DC Reactors

Line Reactor 3%

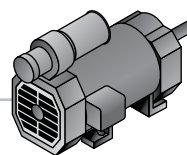
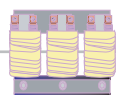

Drive Order Code	230 Vac		460 Vac	
	Input Line Reactor Order Code	Current (A)	Input Line Reactor Order Code	Current (A)
MP25A4(R)	LRL0021A-X	21	LRM0028A-X	21
QMP/MP45A4(R)	LRL0046A-X	46	LRM0046A-X	46
QMP/MP75A4(R)	LRL0083A-X	83	LRM0083A-X	83
MP105A4(R)	LRL0104A-X	104	LRM0104A-X	104
QMP/MP155A4(R)	LRL0160A-X	160	LRM0160A-X	160
QMP/MP210A4(R)	LRL0200A-X	200	LRM0200A-X	200
QMP/MP350A4(R)	LRL0322A-X	322	LRM0322A-X	322
QMP400A4(R)/MP420A4(R)	LRL0414A-X	414	LRM0414A-X	414
QMP/MP550A4(R)	LRL0515A-X	515	LRM0515A-X	515
QMP/MP700A4(R)	LRL0600A-X	600	LRM0600A-X	600
MP825A4(R)	LRL0750A-X	750	LRM0750A-X	750
MP900A4(R)	LRL0850-X	850	LRM0850-X	850
MP1200A4(R)	LRL1200-X	1200	LRM1200-X	1200
MP1850A4(R)	Consult Factory			
	575 Vac		690 Vac	
MP25A5(R)	LRH0028A-X	21		
MP45A5(R)	LRM0046A-X	46		
MP75A5(R)	LRM0065A-X	65		
MP105A5(R)	LRM0104A-X	104		
MP155A5(R)	LRM0160A-X	160		
MP210A5(R)	LRM0200A-X	200		
MP350Ay(R)	LRM0322A-X	322	LRM0322A-X	322
MP470Ay(R)	LRM0414A-X	414	LRM0414A-X	414
MP700Ay(R)	LRM0750A-X	750	LRM0750A-X	750
MP825Ay(R)	LRM0750A-X	750	LRM0750A-X	750
MP1200Ay(R)	LRH1200-X	1200	LRH1200-X	1200
MP1850Ay(R)	Consult Factory			

y = 5 for 575 Vac or 6 for 690 Vac



Isolation Transformers

Drive isolation transformers add an extra margin of protection for AC and DC drives. They are sized to the drive kVA requirements and are designed to withstand the mechanical stress of current reversals and short circuits associated with power semiconductor type AC and DC drives.

- Three-coil, delta-wye configuration with fully rated NEMA 1 enclosure
- ±5% fully rated taps on primary winding
- Ambient temperature: 104 °F (40 °C)
- Standards: ANSI C89.2, NEMA ST-20, UL506, UL1561

Features:

- Provide electrical isolation between the incoming line and the drive electronics
- Convert input line voltage to standard drive input voltages
- Minimize line disturbances caused by SCR power converters
- Reduce power line harmonics caused by drives
- Protect the motor controller by reducing available short circuit potential. This may be a UL requirement in installations with high levels of short circuit potential



Size	Wt. (lbs)	HP	kVA	Primary Voltage	Secondary Voltage		
					230 Vac	460 Vac	
A	150	5	7.5	230	8812-0007-1	8812-0007-2	
				460	8812-0007-3	8812-0007-4	
	160	7.5	11	230	8812-0011-1	8812-0011-2	
				460	8812-0011-3	8812-0011-4	
	170	10	14	230	8812-0014-1	8812-0014-2	
				460	8812-0014-3	8812-0014-4	
B	240	15	20	230	8812-0020-1	8812-0020-2	
				460	8812-0020-3	8812-0020-4	
	300	20	27	230	8812-0027-1	8812-0027-2	
				460	8812-0027-3	8812-0027-4	
	330	25	34	230	8812-0034-1	8812-0034-2	
				460	8812-0034-3	8812-0034-4	
	350	30	40	230	8812-0040-1	8812-0040-2	
				460	8812-0040-3	8812-0040-4	
	430	40	51	230	8812-0051-1	8812-0051-2	
				460	8812-0051-3	8812-0051-4	
	C	530	50	63	230	8812-0063-1	8812-0063-2
					460	8812-0063-3	8812-0063-4
580		60	75	230	8812-0075-1	8812-0075-2	
				460	8812-0075-3	8812-0075-4	
630		75	93	230	8812-0093-1	8812-0093-2	
				460	8812-0093-3	8812-0093-4	
730		100	118	230	8812-0118-1	8812-0118-2	
				460	8812-0118-3	8812-0118-4	
D	830	125	145	230	8812-0145-1	8812-0145-2	
				460	8812-0145-3	8812-0145-4	
	930	150	175	230	8812-0175-1	8812-0175-2	
				460	8812-0175-3	8812-0175-4	
	1350	200	220	230	8812-0220-1	8812-0220-2	
				460	8812-0220-3	8812-0220-4	
E	1500	250	275	230	8812-0275-1	8812-0275-2	
				460	8812-0275-3	8812-0275-4	
	1700	300	330	230	8812-0330-1	8812-0330-2	
				460	8812-0330-3	8812-0330-4	
F	2100	400	440	460		8812-0440-4	
	2350	500	550	460		8812-0550-4	

Order Code

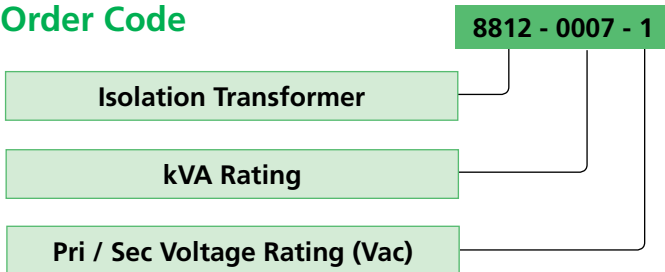

Size	Dims. (in) H x W x D
A	21.5 x 19.4 x 20.2
B	28.8 x 23.9 x 25
C	38 x 26 x 25
D	41 x 32 x 29.5
E	51.5 x 39.5 x 34
F	59 x 48.5 x 38.4

Drive EMC Filters

Electromagnetic Compatibility Filters

EMC filters are used to minimize high-frequency power supply line disturbances caused by drives that may interfere with proper operation of sensitive electronic equipment. These specific filters have been assessed for conformance with the EMC directive by testing with the appropriate Control Techniques brand drives.

EMC data sheets are available for digital drive products. These data sheets list the applicable harmonic standards and give recommended installation techniques and further information on EMC behavior in typical situations.

All Nidec AC and DC Control Techniques drives include internal EMC filters. The filters listed in the following tables are used in addition to the standard onboard filter to provide additional interference reduction. Refer to the specific drive EMC data sheets for details of levels of compliance with IEC standards.

Filter Types

- Low Leakage: low leakage filters limit the leakage current to ground. The length of the motor cable is severely restricted when these filters are applied.
- Standard: standard filters are designed for use in industrial or residential applications with longer motor lead lengths.



AC Drive EMC Filters

115/230 Vac

Drive Order Code	Standard RFI Filter				Low Leakage RFI Filter			
	Order Code	Current (A)	Dims. (in) H x W x D	Weight (lbs)	Order Code	Current (A)	Dims. (in) H x W x D	Weight (lbs)
230 Vac, 1Ø								
SP0201-SP0205	4200-6000	19	14.1 x 2.4 x 1.1	2.6				
230 Vac, 3Ø		Standard RFI Filter			Alternative Standard RFI Filter			
SP0201-SP0205	4200-6001	17	14.1 x 2.4 x 1.1	2.6				
SP1201	4200-6118	10	17.4 x 4 x 1.8	3.1	4200-6121	10	17.7 x 4 x 1.8	4.6
SP1202								
SP1203	4200-6119	16	17.4 x 4 x 1.8	3.1	4200-6120	16	17.7 x 4 x 1.8	4.6
SP1204								
SP2201	4200-6210	32	17 x 6.1 x 2.2	4.4	4200-6211	32	17 x 6.1 x 2.2	7.3
SP2202								
SP2203								
SP3201	4200-6307	75	16.3 x 10 x 2.4	7.7	4200-6306	75	16.8 x 10 x 2.4	11.2
SP3202								
SP4201	4200-6406	101	11.8 x 9 x 4	8.8	4200-6405	101	11.8 x 8.2 x 3.6	17.2
SP4202								
SP4203								
SP5201	4200-6503	164	11.8 x 9.8 x 4.7	15	4200-6501	165	11.8 x 9.8 x 4.7	17.6
SP5202								

AC Drive EMC Filters

460 Vac

Drive Order Code	Standard RFI Filter				Low Leakage RFI Filter			
	Order Code	Current (A)	Dims. (in) H x W x D	Weight (lbs)	Order Code	Current (A)	Dims. (in) H x W x D	Weight (lbs)
460 Vac, 3Ø								
	Standard RFI Filter				Low Leakage RFI Filter			
SP0401-SP0405	4200-6002	11	14.1 x 2.4 x 1.1	2.6				
SP1401	4200-6118	10	17.4 x 4 x 1.8	3.1	4200-6121	10	17.7 x 3.9 x 1.8	4.6
SP1402								
SP1403								
SP1404								
SP1405	4200-6119	16	17.4 x 4 x 1.8	3.1	4200-6120	16	17.4 x 3.9 X 1.8	4.6
SP1406								
SP2401	4200-6210	32	17 x 6.1 x 2.2	4.4	4200-6211	32	17 x 6.1 x 2.2	7.3
SP2402								
SP2403								
SP2404								
SP3401	4200-6305	62	16.3 x 10 x 2.4	7.7	4200-6306	75	16.7 x 9.8 x 2.4	11.2
SP3402								
SP3403								
SP4401	4200-6406	101	11.8 x 9 x 4	8.8	4200-6405	101	11.8 x 8.1 x 3.5	17.2
SP4402								
SP4403								
SP5401	4200-6503	164	11.8 x 9.8 x 4.8	15	4200-6501	165	11.8 x 9.8 x 4.8	26.5
SP5402								
SP6401	4200-6603	260	11.6 x 9 x 5.4	11.6	4200-6601	260	14.3 x 9 x 5.8	19
SP6411								
SP6402								
SP6412								

575/690 Vac

Drive Order Code	Standard RFI Filter				Low Leakage RFI Filter			
	Order Code	Current (A)	Dims. (in.) H x W x D	Weight (lbs)	Order Code	Current (A)	Dims. (in.) H x W x D	Weight (lbs)
575 Vac/690 Vac, 3Ø								
SP3501 - y3507	4200-6309	30	16.3 x 10 x 2.4	7.7	4200-6308	30	16.8 x 9.9 x 2.4	11.2
SP4601 - y4606	4200-6408	58	11.8 x 9 x 4	8.4	4200-6407	58	11.8 x 8.1 x 3.6	17.6
SP5601 - y5602	4200-6504	95	11.8 x 9 x 4	9.7	4200-6502	95	11.8 x 9.8 x 4.8	22
SP6601 - y6602	4200-6604	160	14 x 9 x 5.4	11.6	4200-6602	160	14.3 x 9 x 5.8	19

DC and Servo Drive EMC Filters

DC Drives

Drive Order Code	Armature Supply Filter			Field Supply Filter		
	Order Code	Dims. (in) H x W x D	Weight (lbs)	Order Code	Dims. (in) H x W x D	Weight (lbs)
230 Vac/460 Vac, 1Ø						
MP25A4	FN3258-75-52	10.6 x 3.1 x 5.3	6	FN3280H-8-29	5.6 x 5.6 x 3.1	1.8
QMP/MP45A4						
QMP/MP75A4						
MP105A4	FN3258H-180-40	15 x 4.7 x 6.7	13.2			
QMP/MP155A4						
QMP/MP210A4						
QMP/MP350A4	FN3359-800-99	20.1 x 11 x 7	39.7	FN3280H-25-33	7.1 x 6 x 4.5	2.9
QMP400A4/MP420A4						
QMP/MP550A4						
QMP/MP700A4						
MP825A4						
MP900A4						
MP1200A4	FN3359-1600-99	23.1 x 11.8 x 6.3	59.5			
MP1850A4						

Servo Drives

Drive Order Code	Filter Order Code	Current (A)	Dims. (in) H x W x D	Weight (lbs)
240 Vac, 1Ø				
DST1201-4	4200-6000	19	14.1 x 2.4 x 1.14	2.6
EP202, EP204	960307-01	10	6.14 x 2.26 x 1.79	3.0
EP206	960305-01	16	3.36 x 4.68 x 2.26	2.5
EP209	960308-01	20	2.07 x 6.03 x 2.28	3.0
240 Vac, 3Ø				
DST1201-4	4200-6001	17	14.1 x 2.4 x 1.14	2.6
EP216	960310-01	16	9.84 x 1.77 x 2.76	1.8
480 Vac, 3Ø				
DST1401-5	4200-6002	11	14.1 x 2.4 x 1.14	2.6
MP-1250	MF-1250-20	20	7.28 x 2.75 x 12.67	6.0
MP-2500	MF-2500-35	35	7.28 x 2.75 x 11.81	5.0
MP-5000	MF-5000-65	65	8.66 x 3.74 x 11.81	11.5

Dynamic Braking Resistors

Dynamic Braking (DB)

The DC bus voltage level of an AC drive increases while the motor is re-generating (i.e. ramping to a stop). Dynamic braking resistors provide a means of rapidly stopping a rotating motor and load while maintaining an acceptable bus voltage level. The kinetic energy stored in the spinning mass is converted into electrical energy and quickly dissipated as heat through a resistor. Resistor kits are available for both AC and DC drives.

Dynamic Braking for DC Drives

DC drives provide an exponential stopping profile when a dynamic brake resistor is applied across the motor's armature circuit (when the motor acts as a DC generator). This type of braking can occur only when the drive is configured for coast stop and power has been removed from the motor (stop commanded). To apply a dynamic brake resistor to a DC drive, a motor contactor with a DB pole is required. This motor contactor is standard on Quantum MP drives up through 225 HP (400 A).

Mentor MP and Quantum MP DC drives are available in regenerative models as an energy efficient alternative to dynamic braking. See the Mentor MP/Quantum MP DC drive brochure for details.



Galvanized NEMA1 with normally closed thermostat

Dynamic Braking for AC Drives

AC drives provide a constant torque stopping profile when a dynamic brake resistor is applied across the DC bus circuit. Dynamic braking can be employed under a stop command or anytime a decrease in motor speed is commanded, provided the AC drive is enabled and programmed for ramp stop (fast ramp mode).

Two types of dynamic braking kits are available for Control Techniques AC Drives. The E-stop duty kits are rated for light start/stop or deceleration duty cycles.

The cyclic duty kits are intended for heavy duty applications that need the capability to dissipate regenerated energy on a more continuous or repetitive basis such as downhill conveyors, hoists, feeders and dynamometers.

E-Stop Duty

E-stop duty DB resistors are designed for absorbing energy generated by infrequent motor stops or deceleration.

These kits are designed to meet or exceed NEMA standard 7-15-1970, which states "DB resistors will not exceed their rated temperature rise when the drive is braked from maximum speed to standstill three times in rapid succession with a load inertia equal to or less than the motor inertia." They are designed to provide 150% braking torque (peak at max speed for DC drives, constant for AC drives) for 1800 rpm base speed motors.

Cyclic Duty

The standard packages listed below are NEMA 1 rated and include built-in junction box, terminal strip, normally closed thermal contact (klixon switch) and resistors pre-wired with high-temperature Teflon wire.

These heavy-duty kits have been designed to provide dynamic braking for cyclic and continuous braking applications. There are three levels available: 10%, 25% and 50%. These levels refer to the continuous allowable braking level (i.e. 25% refers to 25% of rated motor braking torque) or the maximum allowable duty cycle rates with maximum specified "on-time" limitations (refer to illustration below).

$$\text{Duty Cycle} = \frac{\text{On Time } (\leq \text{max "on" time})}{\text{On Time} + \text{Off Time}}$$

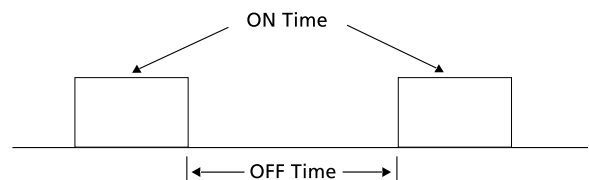

Dynamic Braking Resistors for AC Drives

DB Resistors for AC Drives

Unidrive SP drives are equipped with built-in dynamic braking transistors. Simply select the proper braking resistor needed for the size of drive and duty cycle. Other mounting arrangements and enclosures are available on request.

The brake circuit must include an external thermal protection device connected (as shown in the circuit diagram) unless the resistor has built-in protection.

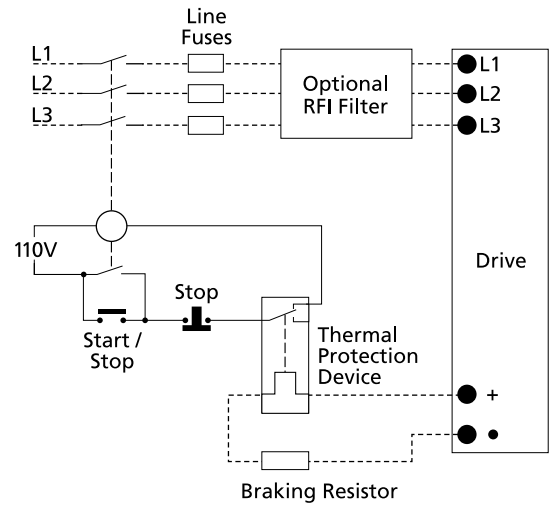

Dynamic Braking Resistors - 230 Vac

Drive Order Code	E-Stop Duty Order Code	Dims. (in) H x W x D	10% Duty Cycle Order Code	Dims. (in) H x W x D	25% Duty Cycle Order Code	Dims. (in) H x W x D	50% Duty Cycle Order Code	Dims. (in) H x W x D		
SP0201	DBR-0400-00300-ENC	5 x 14 x 4	DBR-0400-00300-ENC	5 x 14 x 4	DBR-0400-00300-ENC	5 x 14 x 4	DBR-0400-00300-ENC	5 x 14 x 4		
SP0202										
SP0203					DBR-0400-00500-ENC	5 x 14 x 7	DBR-0400-00500-ENC	5 x 14 x 7	DBR-0400-00500-ENC	5 x 14 x 7
SP0204										
SP0205										
SP1201	DBR-0500-00300-ENC	5 x 14 x 4	DBR-0500-00300-ENC	5 x 14 x 4	DBR-0500-00500-ENC	5 x 14 x 7	DBR-0500-01500-ENC	5 x 14 x 13		
SP1202										
SP1203										
SP1204	DBR-0400-00300-ENC	5 x 14 x 4	DBR-0400-00300-ENC	5 x 14 x 44	DBR-0350-01500-ENC	5 x 14 x 13	DBR-0350-01500-ENC	5 x 14 x 13		
SP2201	DBR-0200-00400-ENC	5 x 14 x 4	DBR-0200-00600-ENC	5 x 14 x 7	DBR-0200-01500-ENC	5 x 14 x 13	DBR-0200-01500-ENC	5 x 14 x 13		
SP2202										
SP2203							DBR-0200-03000-ENC	5 x 28 x 13		
SP3201	DBR-0055-00600-ENC	5 x 14 x 7	DBR-0055-02000-ENC	5 x 14 x 13	DBR-0055-03000-ENC	5 x 21 x 13	DBR-0055-04500-ENC	5 x 28 x 13		
SP3202							DBR-0055-06000-ENC	7 x 29 x 18		
SP4201	DBR-0055-02000-ENC	5 x 14 x 13	DBR-0055-02000-ENC	5 x 14 x 13	DBR-0055-03000-ENC	5 x 21 x 13	DBR-0055-04500-ENC	5 x 28 x 13		
SP4202							DBR-0055-09000-ENC	7 x 29 x 18		
SP4203							DBR-0055-12000-ENC	14 x 29 x 18		
SP5201	DBR-0055-02000-ENC	5 x 14 x 13	DBR-0055-03000-ENC	5 x 21 x 13	DBR-0055-09000-ENC	7 x 29 x 18	DBR-0055-18000-ENC	14 x 29 x 18		
SP5202									DBR-0055-04500-ENC	5 x 28 x 13

* 120V input drives

Dynamic Braking Resistors for AC Drives

460 Vac

Drive Order Code	E-Stop Duty Order Code	Dims. (in) H x W x D	10% Duty Cycle Order Code	Dims. (in) H x W x D	25% Duty Cycle Order Code	Dims. (in) H x W x D	50% Duty Cycle Order Code	Dims. (in) H x W x D						
SP0401	DBR-1200-00300-ENC	5 x 14 x 4	DBR-1200-00300-ENC	5 x 14 x 4	DBR-1200-00300-ENC	5 x 14 x 4	DBR-1200-00300-ENC	5 x 14 x 4						
SP0402					DBR-1200-00800-ENC	5 x 14 x 7	DBR-1200-00800-ENC	5 x 14 x 7	DBR-1200-00800-ENC	5 x 14 x 7				
SP0403											DBR-1200-01500-ENC	5 x 14 x 13	DBR-1200-01500-ENC	5 x 14 x 13
SP0404														
SP0405					DBR-0800-00300-ENC	5 x 14 x 4	DBR-0800-00300-ENC	5 x 14 x 4	DBR-0800-00600-ENC	5 x 14 x 7	DBR-0800-00600-ENC	5 x 14 x 7		
SP1401	DBR-0800-01500-ENC	5 x 14 x 13	DBR-0800-01500-ENC	5 x 14 x 13					DBR-0800-01500-ENC	5 x 14 x 13				
SP1402											DBR-0600-01500-ENC	5 x 14 x 13	DBR-0600-01500-ENC	5 x 14 x 13
SP1403														
SP1404	DBR-0200-00600-ENC	5 x 14 x 7	DBR-0200-00600-ENC	5 x 14 x 7	DBR-0600-01500-ENC	5 x 14 x 13	DBR-0600-01500-ENC	5 x 14 x 13						
SP1405					DBR-0200-03000-ENC	5 x 14 x 13	DBR-0200-03000-ENC	5 x 14 x 13	DBR-0200-03000-ENC	5 x 14 x 13				
SP1406	DBR-0200-04500-ENC	7 x 29 x 18	DBR-0200-04500-ENC	7 x 29 x 18							DBR-0200-04500-ENC	7 x 29 x 18		
SP2401					DBR-0200-06000-ENC	7 x 29 x 18	DBR-0200-06000-ENC	7 x 29 x 18	DBR-0200-06000-ENC	7 x 29 x 18				
SP2402	DBR-0200-09000-ENC	7 x 29 x 18	DBR-0200-09000-ENC	7 x 29 x 18							DBR-0200-09000-ENC	7 x 29 x 18		
SP2403					DBR-0200-12000-ENC	14 x 29 x 18	DBR-0200-12000-ENC	14 x 29 x 18	DBR-0200-12000-ENC	14 x 29 x 18				
SP2404	DBR-0100-03000-ENC	5 x 14 x 13	DBR-0100-03000-ENC	5 x 14 x 13							DBR-0100-03000-ENC	5 x 14 x 13		
SP3401					DBR-0100-06000-ENC	7 x 29 x 18	DBR-0100-06000-ENC	7 x 29 x 18	DBR-0100-06000-ENC	7 x 29 x 18				
SP3402	DBR-0100-12000-ENC	14 x 29 x 18	DBR-0100-12000-ENC	14 x 29 x 18							DBR-0100-12000-ENC	14 x 29 x 18		
SP3403					DBR-0100-18000-ENC	21 x 29 x 18	DBR-0100-18000-ENC	21 x 29 x 18	DBR-0100-18000-ENC	21 x 29 x 18				
SP4401	DBR-0100-24000-ENC	28 x 29 x 18	DBR-0100-24000-ENC	28 x 29 x 18							DBR-0100-24000-ENC	28 x 29 x 18		
SP4402					DBR-0100-36000-ENC	35 x 29 x 18	DBR-0100-36000-ENC	35 x 29 x 18	DBR-0100-36000-ENC	35 x 29 x 18				
SP4403	DBR-0055-06000-ENC	7 x 29 x 18	DBR-0055-06000-ENC	7 x 29 x 18							DBR-0055-06000-ENC	7 x 29 x 18		
SP5401					DBR-0055-09000-ENC	7 x 29 x 18	DBR-0055-09000-ENC	7 x 29 x 18	DBR-0055-09000-ENC	7 x 29 x 18				
SP5402	DBR-0055-12000-ENC	14 x 29 x 18	DBR-0055-12000-ENC	14 x 29 x 18							DBR-0055-12000-ENC	14 x 29 x 18		
SP6401					DBR-0055-24000-ENC	21 x 29 x 18	DBR-0055-24000-ENC	21 x 29 x 18	DBR-0055-24000-ENC	21 x 29 x 18				
SP6402	DBR-0055-36000-ENC	28 x 29 x 18	DBR-0055-36000-ENC	28 x 29 x 18							DBR-0055-36000-ENC	28 x 29 x 18		
SP6411					DBR-0055-50000-ENC	35 x 29 x 18	DBR-0055-50000-ENC	35 x 29 x 18	DBR-0055-50000-ENC	35 x 29 x 18				
SP6412	DBR-0055-60000-ENC	42 x 29 x 18	DBR-0055-60000-ENC	42 x 29 x 18							DBR-0055-60000-ENC	42 x 29 x 18		
SP7411					DBR-0055-12000-ENC	14 x 29 x 18	DBR-0055-12000-ENC	14 x 29 x 18	DBR-0055-12000-ENC	14 x 29 x 18				
SP7412	2x DBR-0055-06000-ENC	7 x 29 x 18 (x2)	2x DBR-0055-06000-ENC	7 x 29 x 18 (x2)							2x DBR-0055-06000-ENC	7 x 29 x 18 (x2)		
SP8411					2x DBR-0055-09000-ENC	7 x 29 x 18 (x2)	2x DBR-0055-09000-ENC	7 x 29 x 18 (x2)	2x DBR-0055-09000-ENC	7 x 29 x 18 (x2)				
SP8412	2x DBR-0055-12000-ENC	14 x 29 x 18 (x2)	2x DBR-0055-12000-ENC	14 x 29 x 18 (x2)							2x DBR-0055-12000-ENC	14 x 29 x 18 (x2)		
SP8413					4x DBR-0055-06000-ENC	7 x 29 x 18 (x4)	4x DBR-0055-06000-ENC	7 x 29 x 18 (x4)	4x DBR-0055-06000-ENC	7 x 29 x 18 (x4)				
SP8414	4x DBR-0055-09000-ENC	7 x 29 x 18 (x4)	4x DBR-0055-09000-ENC	7 x 29 x 18 (x4)							4x DBR-0055-09000-ENC	7 x 29 x 18 (x4)		
SP9411					4x DBR-0055-12000-ENC	14 x 29 x 18 (x4)	4x DBR-0055-12000-ENC	14 x 29 x 18 (x4)	4x DBR-0055-12000-ENC	14 x 29 x 18 (x4)				
SP9412	4x DBR-0055-06000-ENC	7 x 29 x 18 (x4)	4x DBR-0055-06000-ENC	7 x 29 x 18 (x4)							4x DBR-0055-06000-ENC	7 x 29 x 18 (x4)		
SP9413					4x DBR-0055-09000-ENC	7 x 29 x 18 (x4)	4x DBR-0055-09000-ENC	7 x 29 x 18 (x4)	4x DBR-0055-09000-ENC	7 x 29 x 18 (x4)				
SP9414	4x DBR-0055-12000-ENC	14 x 29 x 18 (x4)	4x DBR-0055-12000-ENC	14 x 29 x 18 (x4)							4x DBR-0055-12000-ENC	14 x 29 x 18 (x4)		
SP9415					Consult Factory									

575 Vac

Drive Order Code	E-Stop Duty Order Code	Dims. (in) H x W x D	10% Duty Cycle Order Code	Dims. (in) H x W x D	25% Duty Cycle Order Code	Dims. (in) H x W x D	50% Duty Cycle Order Code	Dims. (in) H x W x D
SP3501	DBR-0200-00600-ENC	5 x 14 x 7	DBR-0200-00600-ENC	5 x 14 x 7	DBR-0200-00600-ENC	5 x 14 x 7	DBR-0200-01500-ENC	5 x 14 x 13
SP3502					DBR-0200-01500-ENC	5 x 14 x 13		
SP3503					DBR-0200-03000-ENC	5 x 28 x 13		
SP3504					DBR-0200-04500-ENC	7 x 29 x 18		
SP3505	DBR-0200-01500-ENC	5 x 14 x 13	DBR-0200-01500-ENC	5 x 14 x 13	DBR-0200-03000-ENC	5 x 28 x 13	DBR-0200-06000-ENC	7 x 29 x 18
SP3506					DBR-0200-04500-ENC	7 x 29 x 18	DBR-0200-09000-ENC	7 x 29 x 18
SP3507								

575 Vac or 690 Vac

Drive Order Code	E-Stop Duty Order Code	Dims. (in) H x W x D	10% Duty Cycle Order Code	Dims. (in) H x W x D	25% Duty Cycle Order Code	Dims. (in) H x W x D	50% Duty Cycle Order Code	Dims. (in) H x W x D
SP4601	DBR-0150-01500-ENC	5 x 14 x 13	DBR-0150-01500-ENC	5 x 14 x 13	DBR-0150-04500-ENC	5 x 28 x 13	DBR-0150-09000-ENC	7 x 29 x 18
SP4602			DBR-0150-03000-ENC	5 x 21 x 13	DBR-0150-06000-ENC	7 x 29 x 18		
SP4603			DBR-0150-09000-ENC	7 x 29 x 18	DBR-0150-12000-ENC	14 x 29 x 18		
SP4604	DBR-0150-03000-ENC	5 x 21 x 13	DBR-0150-04500-ENC	5 x 28 x 13	DBR-0150-12000-ENC	14 x 29 x 18	DBR-0150-18000-ENC	14 x 29 x 18
SP4605			DBR-0150-06000-ENC	7 x 29 x 18	DBR-0150-24000-ENC	21 x 29 x 18		
SP4606			DBR-0150-09000-ENC	7 x 29 x 18	DBR-0150-12000-ENC	14 x 29 x 18		
SP5601	DBR-0120-04500-ENC	5 x 28 x 13	DBR-0120-06000-ENC	7 x 29 x 18	DBR-0120-18000-ENC	14 x 29 x 18	DBR-0120-50000-ENC	28 x 29 x 18
SP5602			DBR-0120-09000-ENC	7 x 29 x 18	DBR-0120-24000-ENC	14 x 29 x 18		
SP6601	DBR-0130-w06000-ENC	7 x 29 x 18	DBR-0120-12000-ENC	14 x 29 x 18	DBR-0120-36000-ENC	21 x 29 x 18	DBR-0130-60000-ENC	35 x 29 x 18
SP6602								



DB Resistors for Servo Drives

115/230/460 Vac

Drive Order Code	Drive kW	Internal Energy Absorption (Joules)	Min Ohms	Drive Heatsink /Internally Mounted			500 Watt UL Listed Panel Mount			500 Watt					
				Order Code (UL Listed)	Watts	Ohms	Order Code	Ohms	Dims. (in) HxWxD	Order Code	Ohms	Dims. (in) HxWxD			
DST1201	0.5	26/7 (115V/230V)	23	SM-HEATSINK-DBR0	50	70	MS-530-00-000	30	13.7 x 3.4 x 9.7	DBR-0400-00500-ENC	40	5 x 14 x 7			
DST1202	1.2	52/14 (115V/230V)	23												
DST1203	1.6	52/14 (115V/230V)	23												
DST1204	2.3	78/21 (115V/230V)	16				SM-HEATSINK-DBR1	50	33	MS-530-00-000	30	13.7 x 3.4 x 9.7	DBR-1200-00800-ENC	120	5 x 14 x 7
DST1401	0.8	13/4 (115V/230V)	111												
DST1402	1.4	13/4 (115V/230V)	111												
DST1403	2	13/4 (115V/230V)	75							MS-530-00-000	30	13.7 x 3.4 x 9.7	DBR-0800-00600-ENC	80	5 x 14 x 7
DST1404	3	13/4 (115V/230V)	28												
DST1405	4.1	13/4 (115V/230V)	28												
EP202	0.77	39/8 (115V/230V)	30	SM-HEATSINK-DBR1	50	33	MS-530-00-000	30	13.7 x 3.4 x 9.7	DBR-0400-00500-ENC	40	5 x 14 x 7			
EP204	1.27	58/12 (115V/230V)	30												
EP206	1.77	97/20 (115V/230V)	30												
EP209	2.32	117/24 (115V/230V)	30				MS-510-00-000	10	13.7 x 3.4 x 9.7	DBR-0200-00600-ENC	20	5 x 14 x 7			
EP216	2.32/4.8	132/28 (115V/230V)	20												
MP-1250	12.5	236/110 (230V/460V)	30												
MP-2500	25	393/183(230V/460V)	30	MS-510-00-000	10	13.7 x 3.4 x 9.7	DBR-0400-00500-ENC	40	5 x 14 x 7						
MP-5000	50	629/293(230V/460V)	9							DBR-0200-00600-ENC	20	5 x 14 x 7			

Drive Order Code	1k Watt			2k Watt			3k Watt		
	Order Code	Ohms	Dims. (in) HxWxD	Order Code	Ohms	Dims. (in) HxWxD	Order Code	Ohms	Dims. (in) HxWxD
DST1203	DBR-0400-01000-ENC	40	5 x 14 x 10	DBR-0300-02000-ENC	30	5 x 21 x 10	DBR-0200-03000-ENC	20	5 x 28 x 13
DST1204									
EP209									
EP216	DBR-0200-01500-ENC	20	5 x 14 x 13	DBR-0100-02000-ENC	10	5 x 14 x 13	DBR-0150-03000-ENC	15	5 x 21 x 13
MP-1250	DBR-0400-01000-ENC	40	5 x 14 x 10						
MP-2500	DBR-0400-01000-ENC	40	5 x 14 x 10						
MP-5000	DBR-0200-01500-ENC	20	5 x 14 x 13						

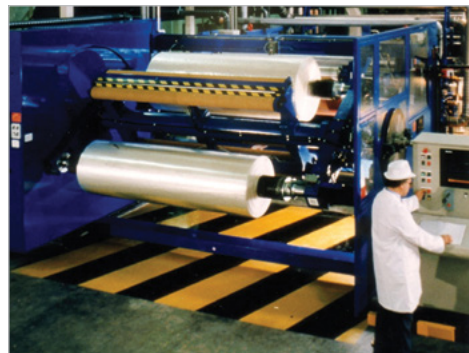

DB Resistors for DC Drives

E-stop duty dynamic braking resistors are available to provide for the fast stopping of DC motors. Quantum MP DC drives up to 400 A include a DB Resistor Pole, which is conveniently located adjacent to the main armature connections.

DB resistors are shipped loose and mounted external to the drive (by customer). NEMA 1 enclosure is galvanized steel and meets the UL508A standard.

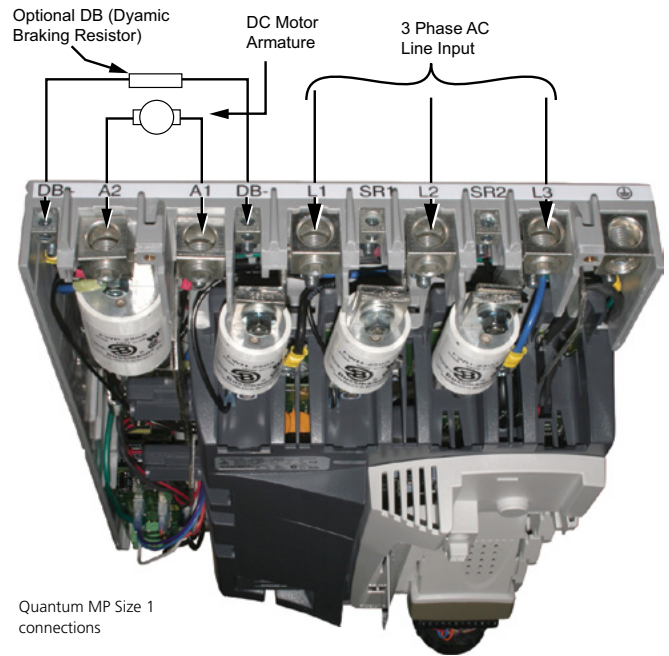

230 Vac DC Drives DB Resistors

Order Code	HP	Ohms	Watts	Dims. (in) H x W x D
005-4301	5	8	128	5 x 14 x 4
005-4302	7.5	5.5	185	
005-4303	10	4.2	243	
005-4304	15	2.9	351	
005-4305	20	2.2	456	
005-4306	25	1.8	570	
005-4307	30	1.5	674	
005-4308	40	1.1	862	
005-4309	50	0.9	1077	5 x 14 x 7
005-4310	60	0.7	1307	
005-4311	75	0.6	1560	5 x 14 x 10
005-4312	100	0.4	2139	
005-4313	125	0.37	2736	5 x 21 x 10
005-4314	150	0.31	3288	
005-4315	200	0.23	4316	5 x 28 x 13

460 Vac DC Drives DB Resistors

Order Code	HP	Ohms	Watts	Dims. (in) H x W x D
005-4351	5-7.5	24.5	180	5 x 14 x 4
005-4352	10	18.5	240	
005-4353	15	12.3	358	
005-4354	20	9.8	453	
005-4355	25	7.7	560	5 x 14 x 7
005-4356	30	6.5	676	
005-4357	40	4.9	880	
005-4358	50	4	1100	5 x 14 x 10
005-4359	60	3.3	1290	
005-4360	75	3.3	1633	5 x 14 x 13
005-4361	100	2	2151	
005-4362	125	1.6	2698	5 x 21 x 13
005-4363	150	1.4	3388	
005-4364	200	1	4356	5 x 28 x 13
005-4365	250	0.8	5780	
005-4366	300	0.6	6762	
005-4367	400	0.5	9250	8.5 x 29 x 18
005-4368	500	0.4	11560	
005-4369	600	0.32	13317	15.5 x 29 x 18
005-4370	700	0.28	15860	
005-4371	800	0.25	18496	



CONTROL TECHNIQUES™

www.controltechniques.com

Connect with us at:

[Twitter.com/Nidec_CTA](https://twitter.com/Nidec_CTA)

[Facebook.com/NidecCTA](https://facebook.com/NidecCTA)

[Youtube.com/c/NidecControlTechniquesAmericas](https://youtube.com/c/NidecControlTechniquesAmericas)

[Linkedin.com/company/control-techniques](https://linkedin.com/company/control-techniques)

theautomationengineer.com (blog)



©2018 Control Techniques a Nidec Motor Corporation business. The information contained in this brochure is for guidance only and does not form part of any contract. The accuracy cannot be guaranteed as Control Techniques has an ongoing process of development and reserves the right to change the specifications of its products without notice. Unidrive and Control Techniques are registered marks of Nidec Control Techniques Limited in the USA.

Control Techniques
7078 Shady Oak Road Eden Prairie, MN 55344-3505 USA