

Installation & Operation Manual

KBDA SERIES

ADJUSTABLE FREQUENCY DRIVES FOR 3-PHASE AC MOTORS
NEMA-4X / IP-65

Washdown and Watertight for Indoor and Outdoor Use

MULTI-FUNCTION KEYPAD WITH 4-DIGIT LED DISPLAY

• Simplified Group Programming • 8 LED Status Indicators

Rated for 208 – 230 and 400/460 Volt 50* & 60 Hz
3-Phase AC Induction Motors from Subfractional thru 5 HP

Operates from 115, 208/230, and 400/460 Volt 50/60 Hz AC Line¹

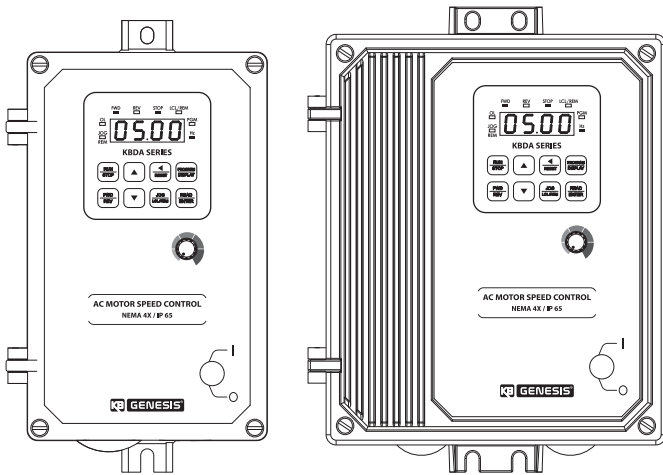

This Manual Covers Models KBDA-24D, 27D, 29, 45, 48



See Safety Warning,
on page 6.



**NOTE: THE DRIVE IS FACTORY SET FOR 60 Hz MOTORS. FOR 50 Hz MOTORS, SEE FIGURE 16, ON PAGE 23.*

The information contained in this manual is intended to be accurate. However, the manufacturer retains the right to make changes in design which may not be included herein.

Notes: 1. Models KBDA-24D, 27D contain an AC line input voltage selection jumper.
2. All models are UL Listed for USA and Canada. 3. Requires CE approved RFI filter.
See AC Line Filters, in Table 1, on page 9.



Automation and Control

TABLE OF CONTENTS

Section	Page
1 Quick-Start Instructions	4
2 Safety Warning	6
3 Introduction	7
4 Important Application Information	16
5 Mounting Instructions	17
6 Electrical Connections	17
7 AC Line Input Voltage Selection (Jumper J1 (Models KBDA-24D, 27D Only))	20
8 Recommended High Voltage Dielectric Withstand Testing (Hi-Pot Testing)	20
9 Drive Operation	21
10 Programmable Function Summary List	31
11 Diagnostic LEDs	41
Appendix A – Optional IODA Input/Output Multi-Function Board	42
Limited Warranty	56
Table	Page
1 Optional Accessories	9
2 General Performance Specifications	9
3 Electrical Ratings	10
4 Drive Terminal Block Wire and Tightening Torque Specifications	18
5 Multi-Function Output Relay “Run” and “Fault” Operating Modes	19
6 Keypad Description	22
7 Digital Readout Codes	30
8 Model Software Revision Codes	40
9 LED Descriptions	41
10 IODA Status Indicator LED	42
11 IODA Terminal Block TB1 Wire and Tightening Torque Specifications	43
12 IODA Functions and Features	44
13 Preset Frequency Selection	45
14 Analog Input 1 Electrical Ratings	50
15 Analog Input 2 Electrical Ratings	50
16 Analog Outputs 1 and 2 Electrical Ratings	51
17 Multi-Function Open Collector Outputs Electrical Ratings	54
Figure	Page
1 Quick-Start Connection Diagram	4
2 Keypad Layout with Main Speed Potentiometer	10
3 Model KBDA-24D Drive Layout	11
4 Model KBDA-27D Drive Layout	12
5 Models KBDA-29, 45, 48 Drive Layout	13
6 Model KBDA-24D Mechanical Specifications	14
7 Models KBDA-27D, 29, 45, 48 Mechanical Specifications	15
8 Maximum Allowed Motor Torque vs. Speed	16
9 Open Ventilated Motor with External Fan Cooling	16
10 Models KBDA-24D, 27D AC Line Input, Motor, and Ground Connections	18
11 Models KBDA-29, 45, 48 AC Line Input, Motor, and Ground Connections	19
12 Multi-Function Output Relay Contacts	19
13 Model KBDA-24D AC Line Input Voltage Selection (Jumper J1)	20
14 Model KBDA-27D AC Line Input Voltage Selection (Jumper J1)	20
15 Typical Hi-Pot Test Setup	21
16 Flow Chart to Program the Drive for 50 Hz Motors	23
17 Flow Chart to Program Motor Current from 6.7 Amps to 5.5 Amps	24
18 Flow Chart to Change Set Frequency from 5.00 Hz to 43.21 Hz	25
19 Flow Chart to Program Accel Time from 1.5 Seconds to 120 Seconds	26

- 20 Flow Chart to Program the Drive to Display Motor RPM 27
- 21 Flow Chart to Program the Drive to Display Custom Units "012.0" 28
- 22 Flow Chart Showing Motor Current, Motor Voltage, and Bus Voltage added to the Basic Display 29
- 23 Function No. Description 31
- 24 IODA Layout (All Models) 43
- 25 IODA Terminal Block TB1 Layout 43
- 26 Preset Frequency Selection Switch or Contact Connections and Function Settings 45
- 27 Up/Down Frequency Control Switch or Contact Connections and Function Settings 46
- 28 Accel/Decel 2 Switch or Contact Connection and Function Settings 46
- 29 Forward/Stop-Reverse/Stop Switch or Contact Connections and Function Settings 47
- 30 External Fault Auxiliary Equipment Switch or Contact Connection and Function Setting 47
- 31 Reset Switch or Contact Connection and Function Setting 47
- 32 2-Wire Start/Stop Switch or Contact Connection and Function Settings 48
- 33 3-Wire Start/Stop Switch or Contact Connection and Function Settings 49
- 34 Analog Input 1 Signal Voltage Following Connection and Function Settings 49
- 35 Analog Input 2 Signal Current Following Connection and Function Settings 50
- 36 Analog Outputs 1 and 2 Connections and Function Settings 51
- 37 Bidirectional Motor Operation Main Speed Potentiometer Connection and Function Setting 52
- 38 Multi-Function Output Relay Contacts Connections and Function Settings 53
- 39 Multi-Function Open Collector Connections and Function Settings 54

Items Included In this Package:

KBDA Adjustable Frequency Drive, KBDA Series Installation and Operation Manual, CE Approved Product Information Card, Warranty Registration Card, and Mounting Template.



RECONDITIONING THE BUS CAPACITORS

If this drive has been in storage for over one year it is necessary to recondition the power supply bus capacitors. To recondition the bus capacitors, apply the AC Line, with the drive in the Stop Mode, for a minimum of one hour. Not following this procedure will cause the bus capacitors to fail.

UL Notice

230 VAC Controls
 Suitable For Use On A Circuit Capable Of Delivering Not More Than 5 kA RMS Symmetrical Amperes, 230 Volts Maximum.
 Use Copper Conductors Rated 75 °C.
 Suitable for Operation in a Maximum Surrounding Air Temperature of 40 °C.

460 VAC Controls
 Suitable For Use On A Circuit Capable Of Delivering Not More Than 5 kA RMS Symmetrical Amperes, 460 Volts Maximum.
 Use Copper Conductors Rated 75 °C.
 Suitable for Operation in a Maximum Surrounding Air Temperature of 40 °C.

IMPORTANT APPLICATION INFORMATION

1. **50 Hz Motors** – This drive has been factory programmed to operate 60 Hz motors. For 50 Hz motor operation, set Function No. 0.00 to "0001". See Figure 16, on page 23.
2. **Motor Current Setting** – The motor current for all drive models is factory set to the maximum drive rating, as shown in Table 3, on page 10. In order for the motor overload protection to operate properly, the drive must be reprogrammed to the actual motor nameplate current. Use Function No. 0.01 to enter the motor nameplate current. See Figure 17, on page 24.
 - a. **Model KBDA-27D** – Has a maximum current rating of 6.7 Amps (2 HP (1.5 kW)) when used with a 208 – 230 Volt 50/60 Hz AC line input (factory setting of motor current and AC line input voltage). When used with 115 Volt 50/60 Hz AC line input (Jumper J1 installed in the "115V" position), the maximum rating of the drive is 5.5 Amps (1½ HP (1.13 kW)). Be sure to reprogram Motor Current (Function No. 0.01) to the actual motor nameplate current rating (not to exceed 5.5 Amps).
 - b. **Model KBDA-29** – Has a maximum rating of 9.0 Amps (3 HP (2.25 kW)) when used with a 208 – 230 Volt 50/60 Hz 3-phase AC line input. When used with a 208 – 230 Volt 50/60 Hz single-phase AC line input, the maximum rating of the drive is 6.7 Amps (2 HP (1.5 kW)). Be sure to reprogram Motor Current (Function No. 0.01) to the actual motor nameplate current rating (not to exceed 6.7 Amps).

1 QUICK-START INSTRUCTIONS

Important: You must read these simplified instructions before proceeding. These instructions are to be used as a reference only and are not intended to replace the details provided herein. You must read the Safety Warning on, page 6, before proceeding.

Note: This drive contains bus capacitors, which must be reconditioned if the drive has been in storage for over 1 year. To recondition the bus capacitors, apply the AC line, with the drive in the Stop Mode, for a minimum of 30 minutes.

See Figure 1. Also see Section 4 - Important Application Information, on page 16.



WARNING! HIGH VOLTAGE – Disconnect main power before making connections to the drive.

FIGURE 1 – QUICK-START CONNECTION DIAGRAM¹

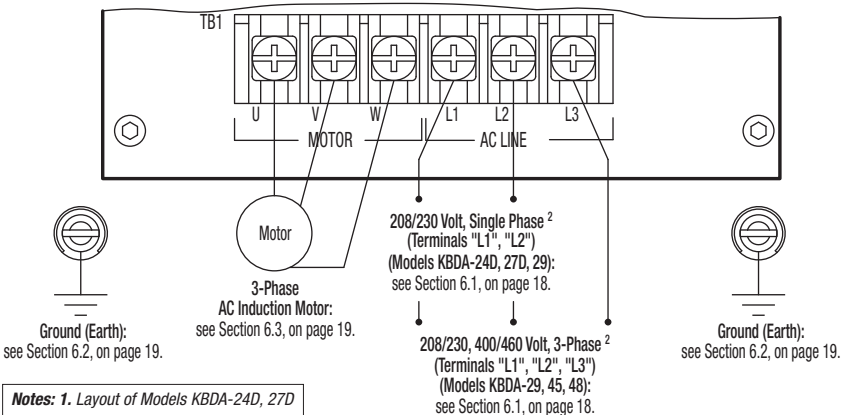

Notes: 1. Layout of Models KBDA-24D, 27D vary slightly. 2. 50/60 Hz AC line input.

- 1.1 AC LINE INPUT CONNECTION** – Connect the AC line input to Terminal Block TB1. See Section 6.1, on page 18.

Application Note – If operation with a Ground-Fault Circuit-Interrupter (GFCI) is required, see Function No. 0.04, on page 32.

Note: The rated AC line voltage of the drive must match the actual AC line input voltage. On Models KBDA-24D, 27D, the setting of Jumper J1 must match the AC line input voltage.

Model KBDA-24D – Terminals “L1”, “L2” – Designed for single-phase AC line input only. Rated for 208/230 Volt AC line input with Jumper J1 set to the “230V” position (factory setting) and rated for 115 Volt AC line input with Jumper J1 set to the “115V” position. See Figure 10, on page 18.

Note: 230 Volts AC will be applied to the motor with 115 Volt AC line input.

Model KBDA-27D – Terminals “L1”, “L2” – Designed for single-phase AC line input only. Rated for 208/230 Volt AC line input with Jumper J1 set to the “230V” position (factory setting) and rated for 115 Volt AC line input with Jumper J1 set to the “115V” position. Rated for 1½ HP maximum with 115 Volt AC line input and 2 HP maximum with 208/230 Volt AC line input. See Figure 10, on page 18.

Note: 230 Volts AC will be applied to the motor with 115 Volt AC line input.

Model KBDA-29 – Terminals “L1”, “L2”, “L3” – Designed for single-phase or 3-phase AC line input. Rated for 208/230 Volt AC line input only. Rated for 2 HP maximum with single-phase AC line input (Terminals “L1”, “L2”) and 3 HP maximum with 3-phase AC line input (Terminals “L1”, “L2”, “L3”). See Figure 11, on page 19.

Models KBDA-45, 48 – Terminals “L1”, “L2”, “L3” – Designed for 3-phase AC line input only. Rated for 400/460 Volt AC line input only. See Figure 11, on page 19.

- 1.2 AC LINE FUSING** – It is recommended that a fuse(s) or circuit breaker be installed in the AC line. Fuse each conductor that is not at ground potential. For the recommended fuse size, see Table 3, on page 10. Also see Section 6.1, on page 18.
- 1.3 GROUND CONNECTION** – Connect the ground wire (earth) to the Ground Screw, as shown in Figures 10 and 11, on pages 18 and 19. Be sure the motor is also properly grounded. Two Ground Screws are provided.
- 1.4 MOTOR CONNECTION** – Connect the motor to Terminal Block TB1 Terminals “U”, “V”, “W”, as shown in Figures 10 and 11, on pages 18 and 19. Be sure the motor is properly grounded. Motor cable length should not exceed 100 ft. (30 m) – special reactors may be required – consult our Sales Department. See Section 6.3, on page 19.
- 1.5 60 Hz and 50 Hz MOTOR OPERATION** – The drive is factory set for 60 Hz motors (Function No. 0.00 set to “0000”). For 50 Hz motors, set Function No. 0.00 to “0001”, as shown in Figure 16, on page 23. For other motor frequencies, set Function No. 0.00 to “0002”.
- 1.6 JUMPER J1 SETTING (Models KBDA-24D, 27D Only)** – Jumper J1 has been factory set for 230 Volt AC line input (installed in the “230V” position). For 115 Volt AC line input, set Jumper J1 to the “115V” position. See Section 7, on page 20.
- 1.7 MOTOR OVERLOAD PROTECTION** – Function No. 0.01 must be set to the motor nameplate current for proper operation of the I²t Motor Overload Protection. See Figure 17, on page 24.

2 SAFETY WARNING

Definition of Safety Warning Symbols



Electrical Hazard Warning Symbol – Failure to observe this warning could result in electrical shock or electrocution.



Operational Hazard Warning Symbol – Failure to observe this warning could result in serious injury or death.



This product should be installed and serviced by a qualified technician, electrician, or electrical maintenance person familiar with its operation and the hazards involved. Proper installation, which includes electrical connections, fusing or other current protection, and grounding, can reduce the chance of electrical shocks, and/or fires, in this product or products used with this product, such as electric motors, switches, coils, solenoids, and/or relays. Do not use this drive in an explosion-proof application. Eye protection must be worn and insulated adjustment tools must be used when working with drive under power. This product is constructed of materials (plastics, metals, carbon, silicon, etc.) which may be a potential hazard. Proper shielding, grounding, and filtering of this product can reduce the emission of radio frequency interference (RFI) which may adversely affect sensitive electronic equipment. It is the responsibility of the equipment manufacturer and individual installer to supply this Safety Warning to the ultimate end user of this product. (SW 1/2006)

The drive contains electronic Start/Stop circuits, which can be used to start and stop the drive. However, these circuits are never to be used as safety disconnects since they are not fail-safe. Use only the AC line for this purpose.

Be sure to read and follow all instructions carefully. Fire and/or electrocution can result due to improper use of this product.



This product complies with all CE directives pertinent at the time of manufacture. Contact our Sales Department for Declaration of Conformity. Installation of a CE approved RFI filter is required. See Table 1, on page 9. For some applications, additional shielded cables, filters, and chokes may be required along with a signal isolator (IODA Input/Output Multi-Function Board (Part No. 9668)).

3 INTRODUCTION

Thank you for purchasing the KBDA Adjustable Frequency Drive. KB Electronics, Inc. is committed to providing total customer satisfaction by producing quality products that are easy to install and operate.

The KBDA Adjustable Frequency Drives are variable speed controls housed in a rugged NEMA-4X / IP-65 washdown and watertight die-cast aluminum enclosure. They are designed to operate 208 – 230 and 400/460 Volt 50 & 60 Hz 3-phase AC induction motors from subfractional thru 5 HP. The sine wave coded Pulse Width Modulated (PWM) output provides high motor efficiency and low noise. Adjustable Linear Acceleration and Deceleration make the drive suitable for soft-start applications.

Due to its user-friendly design, the KBDA is easy to install and operate. Setting the drive to specific applications is accomplished using the Multi-Function Keypad, which provides easy operation and programming of the drive. To facilitate programming, all similar functions are presented in common groups. For more advanced programming, PC based Drive-Link™ software is available.

The 4-Digit LED Display provides readout of drive operating parameters and programming functions and displays Output Frequency, Motor RPM, Output Current, Output Voltage, Bus Voltage, Function Codes and Values, Fault Codes, and Custom Units. In addition to operating the drive, the Multi-Function Keypad is used to change drive operating parameters, reprogram functions, and change the display output. The LEDs provide indication of the drive's status and operating mode (Hz, PGM, LCL/REM, STOP, FWD, REV, OL, JOG/REM).

The optional IODA Input/Output Multi-Function Board provides a variety of functions, which include pre-set frequency, up/down frequency control, signal isolation, isolated output voltage for controlling auxiliary devices, open collector outputs, and output relay contacts. See Appendix A, on pages 42 – 54. See Function Groups 7 – 9, on pages 36 – 38.

Main Features – Adjustable RMS Current Limit and I²t Motor Overload Protection.* Flux Vector Compensation with Static Auto-Tune and Boost provides high torque and excellent load regulation over a wide speed range. Power Start™ delivers over 200% motor torque to ensure startup of high frictional loads. Programmable Injection Braking provides rapid motor stop. Electronic Inrush Current Limit (EICL™) eliminates harmful AC line inrush current, which allows the drive to be line switched. A Multi-Function Output Relay is provided, which can be used to turn on or off equipment or to signal a warning if the drive is put into various modes of operation. Models KBDA-29**, 45, 48 also contain AC Line Phase Loss Detection. The drive is suitable for machine or variable torque (HVAC) applications.

**UL approved as an electronic overload protector for motors.*

***When used on 3-phase AC line input set for 7.0 Amps or higher (3 HP (2.25 kW)).*

Standard Front Panel Features – 4-Digit LED Display, Multi-Function Keypad, Status Indicator LEDs, and a Main Speed Potentiometer.

Optional Accessories – On/Off AC Line Switch, Class "A" AC Line Filter, IODA Input/Output Multi-Function Board, Programming Kit, DIAC Modbus Communication Module, and Liquidtight Fittings. See Table 1, on page 9.

3.1 STANDARD FEATURES

- **Industrial Duty Die-Cast Aluminum Enclosure with Hinged Cover** – Available in dark gray finish or FDA approved white finish.
- **Multi-Function Keypad** – The keys are used to operate the drive, change operating parameters, reprogram functions, and change the display output (Run/Stop, Forward/Reverse, Up, Down, Shift/Reset, Jog-Local/Remote, Program/Display, Read/Enter).
- **4-Digit LED Display** – Provides readout of drive operating parameters and programming functions. Displays Output Frequency, Motor RPM, Output Current, Output Voltage, Bus Voltage, Function No. Codes and Values, Fault Codes, and Custom Units.

- **LED Status Indicators** – The LEDs provide indication of the drive's status and operating mode (Hz, PGM, LCL/REM, STOP, FWD, REV, OL, JOG/REM).
- **Multi-Function Output Relay Contacts** – Can be used to turn on or off equipment or to signal a warning if the drive is put into various modes of operation. (The optional IODA Input/Output Multi-Function Board contains 9 digital and analog inputs, 4 digital and analog outputs, and 2 additional relay outputs.)
- **Motor Current Selection** – Programmable motor current allows the drive to be used on a wide range of motor horsepower.
- **Compatible with GFCIs.** See Function No. 0.04, on page 32.

3.2 PERFORMANCE FEATURES

- **Power Start™** – Provides more than 200% starting torque which ensures startup of high frictional loads.
- **Programmable Flux Vector Compensation with Static Auto-Tune and Boost** – Provides excellent load regulation and dynamic response over a wide speed range.
- **Speed Range – 60:1**

3.3 PROTECTION FEATURES

- **Motor Overload (I^2t) with RMS Current Limit** – Provides motor overload protection, which prevents motor burnout and eliminates nuisance trips.*
- **Electronic Inrush Current Limit (EICL™)** – Eliminates harmful inrush AC line current during startup.
- **Short Circuit** – Shuts down the drive if a short circuit occurs at the motor (phase-to-phase).
- **AC Line Phase Loss Detection** (Models KBDA-29**, 45, 48 only.)
- **Decel Extend** – Eliminates tripping due to bus overvoltage caused by rapid deceleration of high inertial loads.
- **Undervoltage and Overvoltage** – Shuts down the drive if the AC line input voltage goes below or above the operating range.
- **MOV Input Transient Suppression.**
- **Microcontroller Self Monitoring and Auto-Reboot.**

**UL approved as an electronic overload protector for motors.*

***When used on 3-phase AC line input set for 7.0 Amps or higher (3 HP (2.25 kW)).*

TABLE 1 – OPTIONAL ACCESSORIES

Description	Accessory Part No.				
	Model KBDA-24D	Model KBDA-27D	Model KBDA-29	Model KBDA-45	Model KBDA-48
On/Off AC Line Switch – Disconnects the AC line. Mounts on the enclosure cover and is supplied with a switch seal to maintain liquidtight integrity.	9482	9523	9532	9532	9532
AC Line Filter¹ – Provides Class A Industrial Standard RFI (EMI) suppression. Installs onto the drive's PC board with quick-connect terminals. Suffix "S" – Filter must be used with built-in On/Off AC Line Switch. Suffix "NS" – Filter must be used without On/Off AC Line Switch.	Suffix "S"	9507	9512	9479	9479
	Suffix "NS"	9507	9512	9515	9515
IODA Input/Output Multi-Function Board – Provides a variety of functions, which include preset frequency, up/down frequency control, signal isolation, isolated output voltage for controlling auxiliary devices, open collector outputs, and output relay contacts. Mounts on the drive's PC board with two snap-ins (located on the bottom of the mounting base) and two screws (provided). All of the IODA inputs and outputs are isolated from the AC line. See Appendix A, on page 42.	9668	9668	9668	9668	9668
Programming Kit – Includes Download Module™ (DLM) handheld programming device, which uploads and downloads drive programs, PC to DLM serial and USB communication cables, DLM to inverter communication cable, and PC Windows® based Drive-Link™ communication software.	9582	9582	9582	9582	9582
DIAC Modbus Communication Module – Allows direct communication between drive and Modbus ² protocol.	9517	9517	9517	9517	9517
Liquidtight Fittings – Provide a liquidtight seal for wiring the drive. Kit includes three 1/2" and one 3/4" liquidtight fittings.	9526	9526	9526	9526	9526

Notes: 1. Complies with CE Council Directive 89/336/EEC Industrial Standard. 2. Other protocols available – contact our Sales Department.

TABLE 2 – GENERAL PERFORMANCE SPECIFICATIONS

Description	Specification	Factory Setting
115 Volt AC Line Input Voltage Operating Range (Volts AC)	115 (± 15%)	—
208/230 Volt AC Line Input Voltage Operating Range (Volts AC)	208 (-15%) / 230 (+15%)	—
400/460 Volt AC Line Input Voltage Operating Range (Volts AC)	380 (-15%) – 460 (+15%)	—
Maximum Load (% of Current Overload for 2 Minutes)	150	—
Switching Frequency (kHz)	8, 10, 12	8
Signal Following Input Voltage Range ¹ (Volts DC)	0 – 5	—
Output Frequency Resolution (Bits, Hz)	10, .06	—
Minimum Operating Frequency at Motor (Hz)	0.3	—
Acceleration Time (Seconds)	0.1 – 180.0	1.5
Deceleration Time (Seconds)	0.3 – 180.0	1.5
Speed Range (Ratio)	60:1	—
Speed Regulation (30:1 Speed Range, 0 – Full Load) (% Base Speed) ²	2.5	—
Overload Protector Trip Time for Stalled Motor (Seconds)	6	—
Undervoltage/Overvoltage Trip Points for 115 Volt AC Line Input (± 5%) (Volts AC) ³	76 / 141	—
Undervoltage/Overvoltage Trip Points for 208/230 Volt AC Line Input (± 5%) (Volts AC) ³	151 / 282	—
Undervoltage/Overvoltage Trip Points for 400/460 Volt AC Line Input (± 5%) (Volts AC) ³	302 / 567	—
Run/Fault Output Relay Contact Rating (Amps at 30 Volts DC, 125 Volts AC, 250 Volts AC)	1, 0.5, 0.25	—
Operating Temperature Range (°C / °F)	0 – 45 / 32 – 113	—

Notes: 1. IODA option board required. 2. Dependent on motor performance. 3. Do not operate the drive outside the specified AC line input voltage operating range.

TABLE 3 – ELECTRICAL RATINGS

Model	Part No. (Gray / White 1)	AC Line Input			Fuse or Circuit Breaker Rating (Amps AC)	Output			Net Wt.	
		Volts AC ² (50/60 Hz)	Phase (ϕ)	Maximum Current (Amps AC)		Voltage Range (Volts AC)	Maximum Continuous Load Current ³ (RMS Amps/Phase)	Maximum Horsepower (HP (kW))	lbs	kg
KBDA-24D ⁴	9536/9537	115	1	14	20	0 – 230	3.6	1 (.75)	5.9	2.7
		208/230	1	8.1	15					
KBDA-27D ^{4,5}	9543/9544	115	1	22	25	0 – 230	5.5	1½ (1.13)	10.3	4.7
		208/230	1	16.7	20	0 – 230	6.7³	2 (1.5)		
KBDA-29 ^{6,7}	9545/9546	208/230	1	20.5	20	0 – 230	6.7	2 (1.5)	10.3	4.7
			3	11.7	15	0 – 230	9³	3 (2.25)		
KBDA-45 ^{7,8}	9659/9660	400/460	3	7.2	10	0 – 400/460	5.5	3 (2.25)	10.3	4.7
KBDA-48 ^{7,8}	9661/9662	400/460	3	11	15	0 – 400/460	8.3	5 (3.75)	10.3	4.7

Notes: 1. White FDA approved finish. 2. Bold indicates factory setting of AC line input voltage for Models KBDA-24D, 27D. 3. Factory setting of motor current (Function No. 0.01). 4. Models KBDA-24D, 27D contain an AC line input voltage selection jumper. 5. Model KBDA-27D is rated 1½ HP (1.13 kW) with 115 Volt AC line input and 2 HP (1.5 kW) with 208/230 Volt AC line input. 6. Model KBDA-29 is rated 2 HP (1.5 kW) with single-phase AC line input and 3 HP (2.25 kW) with 3-phase AC line input. 7. Also contain AC Line Phase Loss Detection (Model KBDA-29: when used on 3-phase AC line input set for 7.0 Amps or higher (3 HP (2.25 kW))). 8. Models KBDA-45, 48 are rated 0 – 400 Volts AC for 50 Hz motor operation and 0 – 460 Volts AC for 60 Hz motor operation.

FIGURE 2 – KEYPAD LAYOUT WITH MAIN SPEED POTENTIOMETER

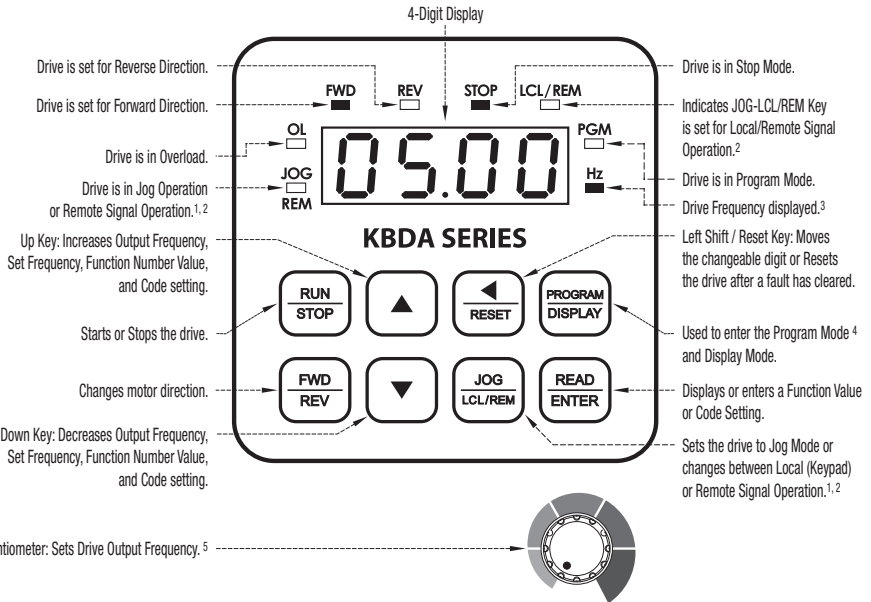

Notes: 1. The JOG-LCL/REM Key is factory programmed to function as a Jog Key. When the JOG-LCL/REM Key is pressed, the "JOG/REM" LED will illuminate and the display will show the Jog Frequency Setting (see Function No. 3.13, on page 34). 2. If the JOG-LCL/REM Key is reprogrammed for Local (Keypad) and Remote Signal Operation (see Function No. 2.02, on page 34), the "LCL/REM" LED will illuminate. Pressing the JOG-LCL/REM Key will toggle between Local (Keypad) and Remote Signal Operation. When Remote Signal Operation is selected, the "JOG/REM" LED will flash. The optional IODA (Part No. 9668) is required for remote signal operation. 3. The "Hz" LED will illuminate when the display is set to show Output Frequency. 4. If the PROGRAM/DISPLAY Key is pressed while Set Frequency is displayed, the previously entered Function Number will be shown. If the PROGRAM/DISPLAY Key is pressed while Function Number is displayed, the Set Frequency will be shown. When more than one display function is enabled, the PROGRAM/DISPLAY Key is used to toggle between displays, as shown in Figure 22, on page 29. 5. To change the Keypad for Potentiometer Operation, set Function No. 2.00 to "0001".

FIGURE 3 – MODEL KBDA-24D DRIVE LAYOUT

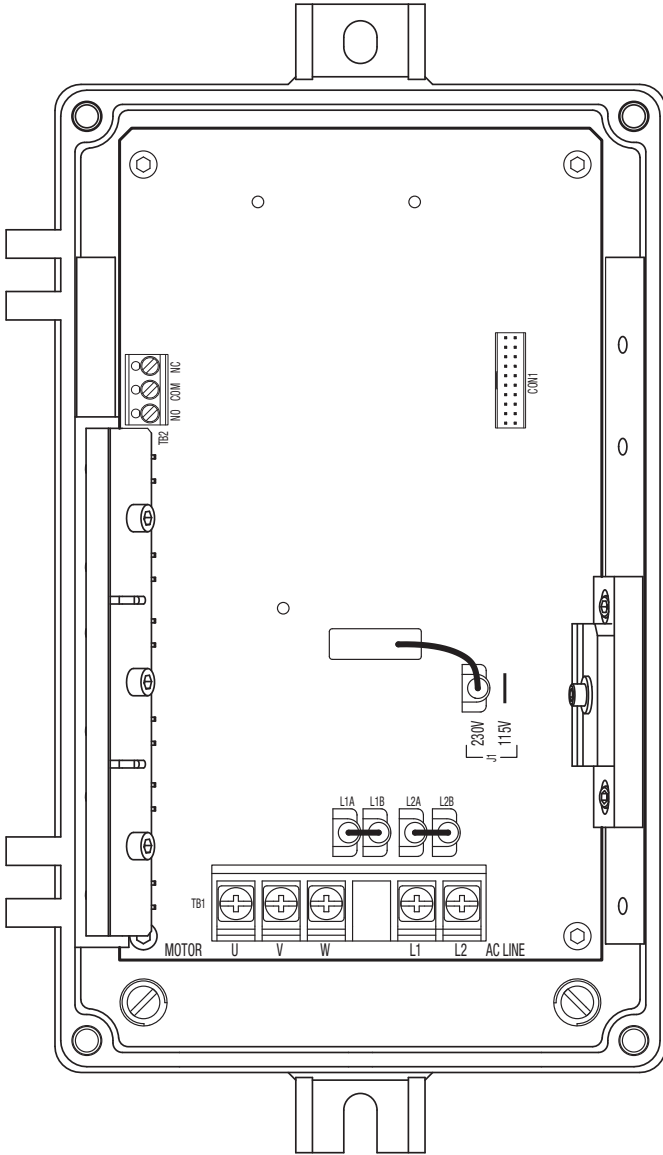

FIGURE 4 – MODEL KBDA-27D DRIVE LAYOUT

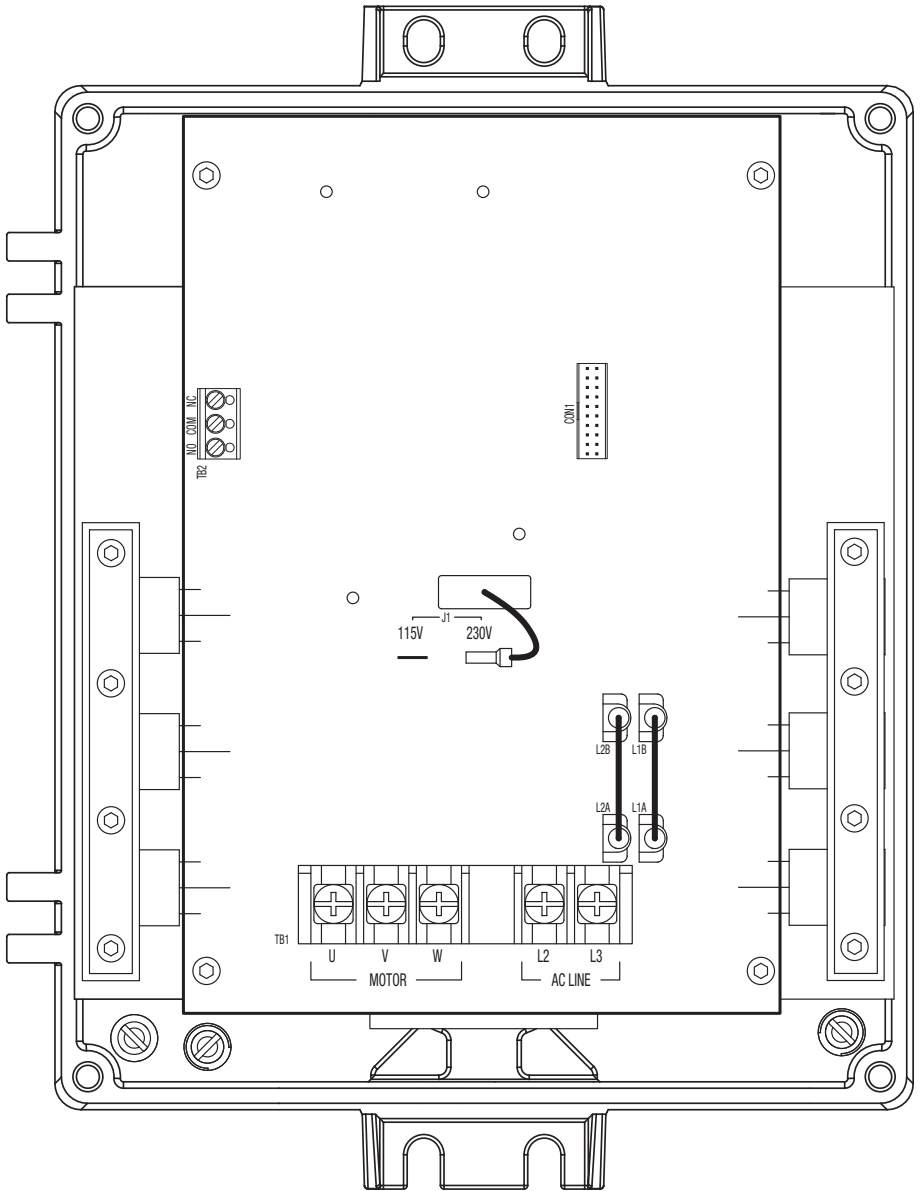

FIGURE 5 – MODELS KBDA-29, 45, 48 DRIVE LAYOUT

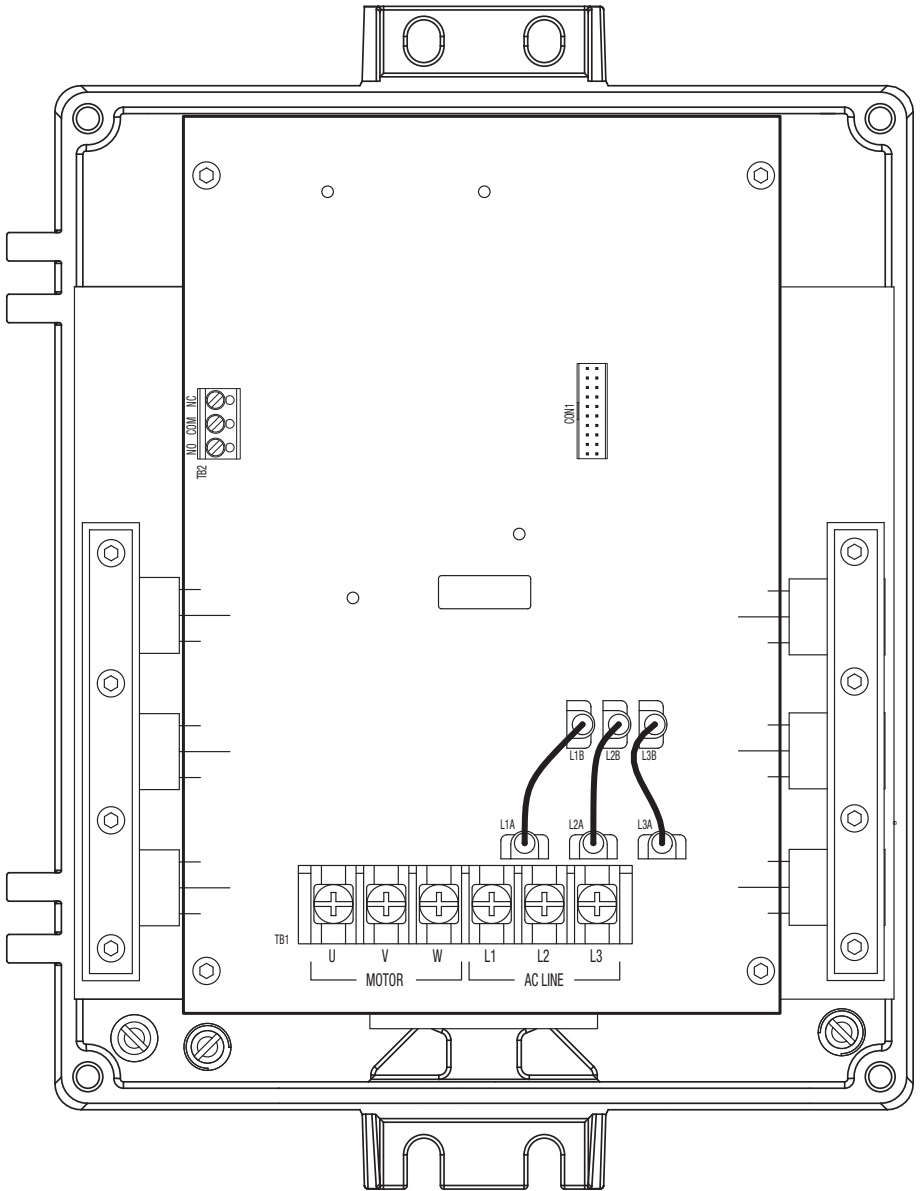
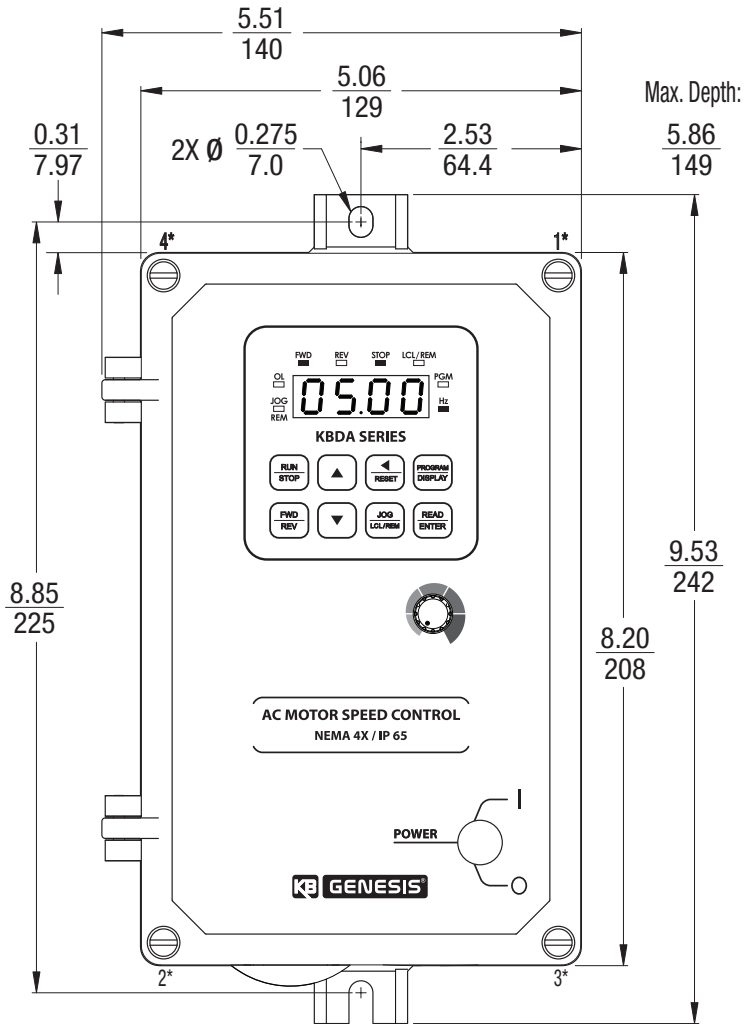
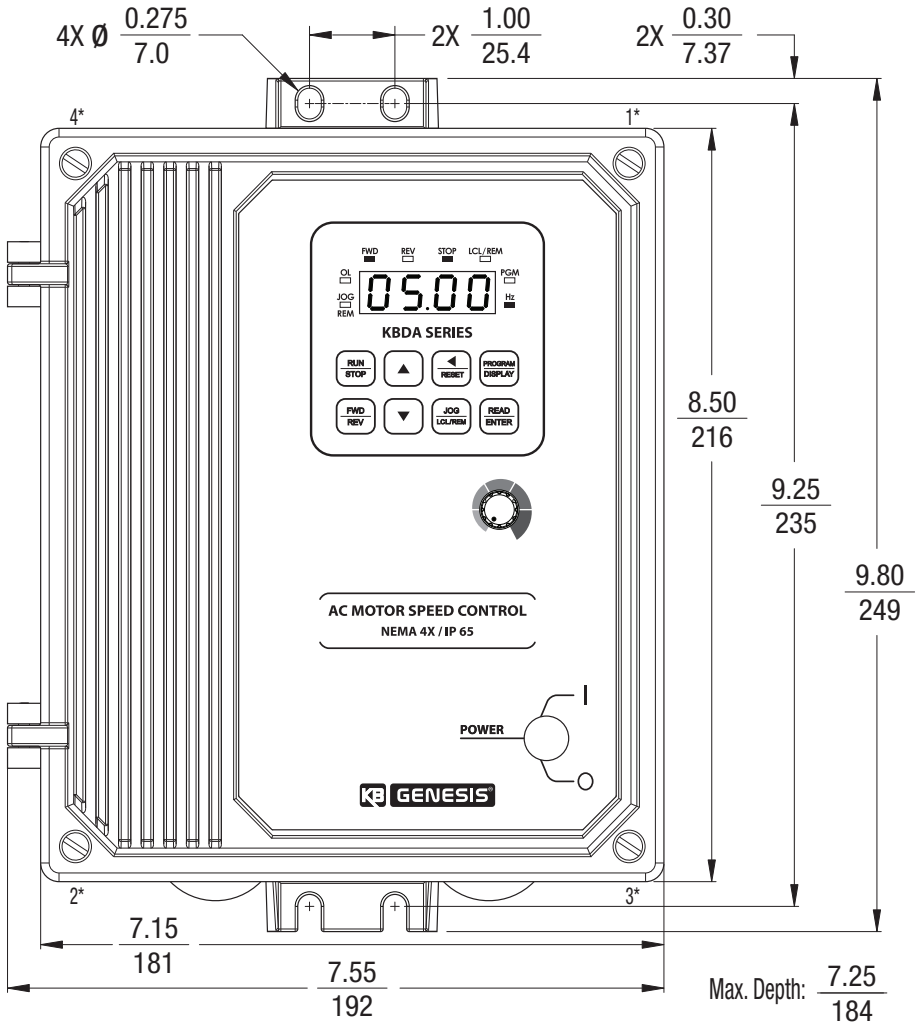

FIGURE 6 – MODEL KBDA-24D MECHANICAL SPECIFICATIONS (Inches/mm)



Model KBDA-24D contains mounting holes for standard 1/2" liquidtight fittings. The recommended mounting screw size is 1/4" (M6).
 *Tighten the four enclosure cover screws, in the sequence shown, to 12 in-lbs (14 kg-cm).

FIGURE 7 – MODELS KBDA-27D, 29, 45, 48 MECHANICAL SPECIFICATIONS (Inches/mm)



Models KBDA-27D, 29, 45, 48 contain two mounting holes for standard 1/2" liquidtight fittings and one mounting hole for standard 3/4" liquidtight fitting. The recommended mounting screw size is 1/4" (M6).

*Tighten the four enclosure cover screws, in the sequence shown, to 12 in-lbs (14 kg-cm).

4 IMPORTANT APPLICATION INFORMATION

- 4.1 MOTOR WITH EXTERNAL FAN COOLING** – Most totally enclosed fan-cooled (TEFC) and open ventilated 3-phase AC induction motors will overheat if used beyond a limited speed range at full torque. Therefore, it is necessary to reduce motor load as speed is decreased.

Note: Some fan-cooled motors can be used over a wider speed range. Consult the motor manufacturer for details.



WARNING! Some motors have low speed characteristics, which cause overheating and winding failure under light load or no load conditions. If the motor is operated in this manner for an extended period of time, it is recommended that the unloaded motor current be checked from 2 – 15 Hz (60 – 450 RPM) to ensure motor current does not exceed the nameplate rating. If the motor current exceeds the nameplate rating, the Boost value may have to be decreased (see Function No. 3.11). **Do not use motor if the motor current exceeds the nameplate rating.**



It is recommended that the drive be used with Inverter Duty or TENV motors.

FIGURE 8 – MAXIMUM ALLOWED MOTOR TORQUE VS. SPEED

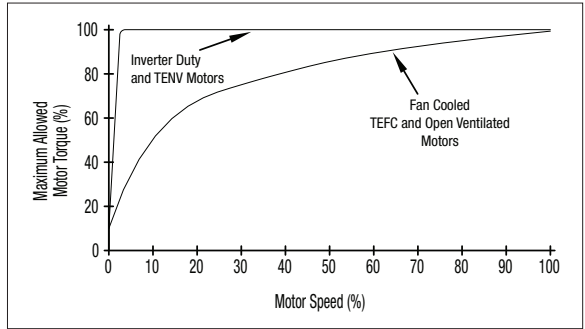
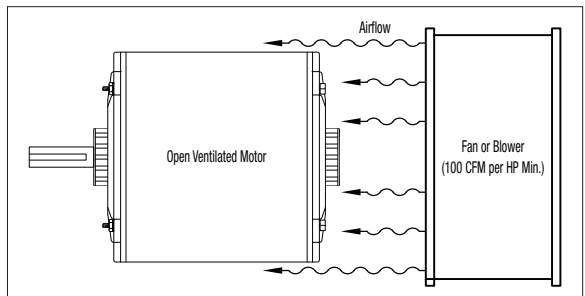

FIGURE 9 – OPEN VENTILATED MOTOR WITH EXTERNAL FAN COOLING



Inverter duty and most totally enclosed non-ventilated (TENV) motors can provide full rated torque over an extended speed range without overheating. See Figure 8.

If external fan cooling is provided, open ventilated motors can also achieve an extended speed range at full rated torque. A box fan or blower with a minimum of 100 CFM per HP is recommended. Mount the fan or blower so the motor is surrounded by the airflow. See Figure 9.

- 4.2 ELECTRONIC MOTOR OVERLOAD PROTECTION** – The drive contains Modified I^2t Overload Protection.* Part of this function consists of a Current Limit (CL) circuit, which limits the drive current to a preset level of 160% of the Motor Nameplate Rated Current setting. **The factory setting for motor nameplate current is the drive rated current, which must be set to the actual motor nameplate current (see Important Application Information (Item 2), on page 4). See Table 3, on page 10. Also see Function No. 0.01, on page 32.**

Standard I^2t is undesirable because it causes nuisance tripping. It allows a very high motor current to develop and will turn the drive off after a short period of time. KB's RMS Current Limit Circuit avoids this nuisance tripping while providing maximum motor protection.

If the motor is overloaded to 120% of the Motor Nameplate Rated Current setting, the I^2t Timer starts. If the motor continues to be overloaded at the 120% level, the timer will shut down the drive after 30 minutes. If the motor is overloaded to 160% of full load, the drive will trip in 6 seconds.

**UL approved as an overload protector for motors.*

5 MOUNTING INSTRUCTIONS

It is recommended that the drive be mounted vertically on a flat surface with adequate ventilation. Leave enough room below the drive to allow for AC line, motor connections, and any other connections that are required. Although the drive is designed for outdoor and washdown use, care should be taken to avoid extreme hazardous locations where physical damage can occur. When mounting the drive in an enclosure, the enclosure should be large enough to allow for proper heat dissipation so that the ambient temperature does not exceed 45°C (113 °F) at full rating. The recommended mounting screw size is 1/4 inch (M6). See Figures 6 and 7, on pages 14 and 15.



**WARNING! Do not use this drive in an explosion-proof application.
Be sure the drive is securely mounted.**

6 ELECTRICAL CONNECTIONS



WARNING! HIGH VOLTAGE – Read Safety Warning, on page 6, before using the drive.

Disconnect main power before making connections to the drive. To avoid electric shock, be sure to properly ground the drive.

Application Note: To avoid erratic operation, do not bundle the AC line and motor wires with each other or with wires from signal following, start/stop contacts, or any other signal wires. Also, do not bundle motor wires from multiple drives in the same conduit. Use shielded cables on all signal wires over 12" (30 cm). The shield should be earth grounded on the drive side only. Connect the drive in accordance with the National Electrical Code requirements and other local codes that may apply.

Be sure to properly fuse each AC line conductor that is not at ground potential. Do not fuse neutral or grounded conductors. A separate AC line switch or contactor must be installed as a disconnect so that each ungrounded conductor is opened. For fuse or circuit breaker selection, see Table 3, on page 10. Also see Section 6.1, on page 18.

To maintain the watertight integrity of the drive, be sure to use suitable liquidtight fittings and wires that are appropriate for the application. Model KBDA-24D contains mounting holes for standard 1/2" liquidtight fittings (not supplied) (two liquidtight plugs are provided, if only one knockout is used). Models KBDA-27D, 29, 45, 48 contain two mounting holes for standard 1/2" liquidtight fittings (not supplied) and one mounting hole for standard 3/4" liquidtight fitting (not supplied) (two liquidtight plugs are provided, if only one knockout is used). The Liquidtight Fittings Kit (Part No. 9526) is available for all models (see Table 1, on page 9).

The drive is designed with a hinged case so that, when the front cover is open, all wires stay intact. To open the cover, the four screws must be loosened so they are no longer engaged in the case bottom. After mounting the drive and all electrical connections are complete, close the cover making sure that the wires do not get caught or crimped as the cover is closed. Tighten the four screws so that the gasket is slightly compressed. The recommended tightening torque is 12 in-lbs (14 kg-cm). See Figures 6 and 7, on pages 14 and 15, for the tightening sequence. Do not overtighten.

TABLE 4 – DRIVE TERMINAL BLOCK WIRE AND TIGHTENING TORQUE SPECIFICATIONS

Terminal Block	Description	Model	Maximum Wire Size (Cu)		Recommended Tightening Torque	
			AWG	mm ²	in-lbs	kg-cm
TB1	AC Line Input and Motor Connections	KBDA-24D	12	3.3	7	8
		KBDA-27D, 29, 45, 48	12	3.3	12	14
TB2	Run/Fault Output Relay Contacts	All	16	1.3	3.5	4

6.1 AC LINE INPUT CONNECTION (see Warning, on page 17) – Connect the AC line input to Terminal Block TB1. See Electrical Ratings, Table 3, on page 10.

Application Note: If operation with a Ground-Fault Circuit-Interrupter (GFCI) is required, see Function No. 0.04, on page 32.

Note: The rated AC line voltage of the drive must match the actual AC line input voltage. On Models KBDA-24D, 27D, the setting of Jumper J1 must match the AC line input voltage.

AC Line Fusing – The drive does not contain line fuses. Most electrical codes require that each ungrounded conductor contain circuit protection. **Do not fuse neutral or ground connections.** It is recommended to install a fuse (Littelfuse 326, Buss ABC, or equivalent) or a circuit breaker (Square D QOU or equivalent) in series with each ungrounded conductor. **Do not fuse motor leads.** For the recommended fuse size, see Table 3, on page 10.

Connect the drive in accordance with the National Electrical Code requirements and other local codes that may apply to the application.

Model KBDA-24D –

Terminals “L1”, “L2” – Designed for single-phase AC line input only. Rated for 208/230 Volt AC line input with Jumper J1 set to the “230V” position (factory setting) and rated for 115 Volt AC line input with Jumper J1 set to the “115V” position. See Figure 10.

Note: 230 Volts AC will be applied to the motor with 115 Volt AC line input.

FIGURE 10 – MODELS KBDA- 24D, 27D*
AC LINE INPUT, MOTOR, AND GROUND CONNECTIONS

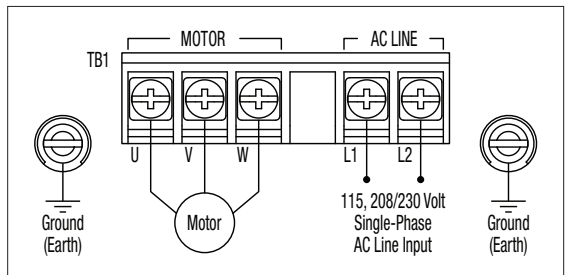

*Model KBDA-27D is rated for 1 1/2 HP maximum with 115 Volt AC line input and 2 HP maximum with 208/230 Volt AC line input.

Model KBDA-27D – Terminals “L1”, “L2” – Designed for single-phase AC line input only. Rated for 208/230 Volt AC line input with Jumper J1 set to the “230V” position (factory setting) and rated for 115 Volt AC line input with Jumper J1 set to the “115V” position. Rated for 1 1/2 HP maximum with 115 Volt AC line input and 2 HP maximum with 208/230 Volt AC line input. See Figure 10.

Note: 230 Volts AC will be applied to the motor with 115 Volt AC line input.

Model KBDA-29 – Terminals “L1”, “L2”, “L3” – Designed for single-phase or 3-phase AC line input. Rated for 208/230 Volt AC line input only. Rated for 2 HP maximum with single-phase AC line input (Terminals “L1”, “L2”) and 3 HP maximum with 3-phase AC line input (Terminals “L1”, “L2”, “L3”). See Figure 11, on page 19.

Models KBDA-45, 48 – Terminals “L1”, “L2”, “L3” – Designed for 3-phase AC line input only. Rated for 400/460 Volt AC line input only. See Figure 11, on page 19.

**FIGURE 11 – MODELS KBDA-29¹, 45², 48²
AC LINE INPUT, MOTOR, AND GROUND CONNECTIONS**

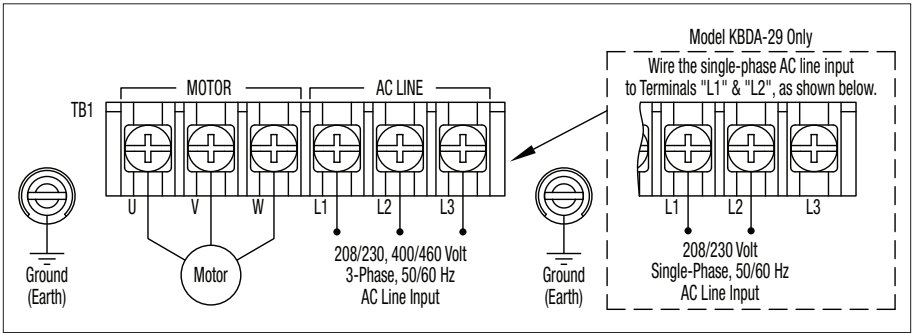

Notes: 1. Model KBDA-29 is rated for 2 HP maximum with single-phase AC line input and 3 HP maximum with 3-phase AC line input.
2. Models KBDA-29, 45, 48 contain AC Line Phase Loss Detection. (Model KBDA-29: when used on 3-phase AC line input set for 7.0 Amps or higher (3 HP (2.25 kW)).

6.2 GROUND CONNECTION – Connect the ground wire (earth) to any available green Ground Screw. The two Ground Screws are located near Terminal Block TB1. Be sure the motor is also properly grounded. See Figure 10, on page 18, and Figure 11, above.

6.3 MOTOR CONNECTION – Connect the motor to Terminal Block TB1 Terminals “U”, “V”, “W”. See Figure 10, on page 18, and Figure 11, above. Be sure the motor is properly grounded. Motor cable length should not exceed 100 ft. (30 m) – special reactors may be required – consult our Sales Department. Be sure Function No. 0.01 is set to the corresponding Motor Nameplate Current.

Note: If the motor does not rotate in the desired direction, either: 1. Reverse any two motor leads (with AC line disconnected and motor stopped). or 2. Use the FWD/REV Key. or 3. Use Function No. 1.02 to reprogram the forward and reverse direction.

6.4 MULTI-FUNCTION OUTPUT RELAY CONNECTION – The Multi-Function Output Relay Contacts are located at TB2, as shown in Figure 12. The Multi-Function Output Relay is factory programmed to function as a “Run” relay (Function No. 5.00 set to “0000”). When the drive is put into the Run Mode, the relay contacts will change state (the Normally Open (N.O.) contact will close and the Normally Closed (N.C.) contact will open). See Table 5.

FIGURE 12 – MULTI-FUNCTION OUTPUT RELAY CONTACTS

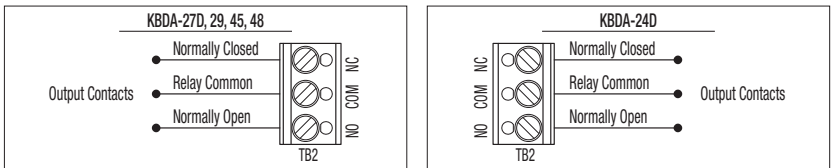

TABLE 5 – MULTI-FUNCTION OUTPUT RELAY “RUN” AND “FAULT” RELAY OPERATING MODES

Drive Operating Condition	Function 5.00 Set to “0000”		Function 5.00 Set to “0001”	
	“Run” Relay Mode		“Fault” Relay Mode	
	N.O. Contact	N.C. Contact	N.O. Contact	N.C. Contact
Power Off	Open	Closed	Open	Closed
Power On (Stop Mode)	Open	Closed	Closed	Open
Run Mode	Closed	Open	Closed	Open
All Faults	Open	Closed	Open	Closed

When the Multi-Function Output Relay is programmed to function as a “Fault” relay (Function No. 5.00 set to “0001”) and a fault occurs while the drive is in the Run Mode, the relay contacts will change state. The Normally Open (N.O.) contact (closed in the Run Mode) will open and the Normally Closed (N.C.) contact (open in the Run Mode) will close. See Table 5, on page 19.

The Multi-Function Output Relay can also be programmed for the following functions, as shown in the Programmable Function Summary List (Section 10, Function Group 5, on page 35): Target Frequency, Frequency Threshold, I²t or I-t Fault Mode, and Load Loss.

6.5 REMOTE OPERATIONS WHICH REQUIRE THE OPTIONAL IODA (PART NO. 9668)

(See Appendix A, on pages 42 – 54)

Multi-Function Input Terminals (Preset Frequency Operation, Up/Down Frequency Command, Accel/Decel 2, Forward/Stop-Reverse/Stop Command, External Fault, Reset, 2-Wire and 3-Wire Start/Stop), Signal Following, Analog Signal Output (for controlling auxiliary devices), Remote Main Speed Potentiometer (5 kΩ), Multi-Function Output Relays, and Multi-function Open Collector Outputs.

7 AC LINE INPUT VOLTAGE SELECTION (JUMPER J1 (MODELS KBDA-24D, 27D ONLY))



Do not connect the AC line input until Jumper J1 is set for the proper input voltage being applied to the drive. Catastrophic failure will occur if a 230 Volt AC line is applied when the drive is set for 115 Volt AC line input.

Jumper J1 is factory installed on Terminal “230V” for 208/230 Volt AC line input. For 115 Volt AC line input, the jumper must be removed and installed on Terminal “115V”. See Figures 13 and 14.

FIGURE 13 – MODEL KBDA-24D AC LINE INPUT VOLTAGE SELECTION

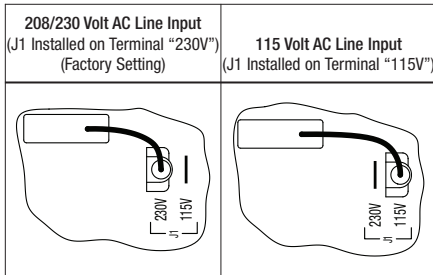
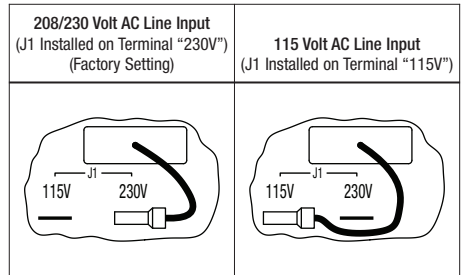

FIGURE 14 – MODEL KBDA-27D AC LINE INPUT VOLTAGE SELECTION



8 RECOMMENDED HIGH VOLTAGE DIELECTRIC WITHSTAND TESTING (HI-POT TESTING)

Testing agencies such as UL, CSA, VDE, etc., usually require that equipment undergo a hi-pot test. In order to prevent catastrophic damage to the drive, which has been installed in the equipment, the following procedure is recommended. A typical hi-pot test setup is shown in Figure 15, on page 21. All drives have been factory hi-pot tested in accordance with UL requirements.

WARNING! All equipment AC line inputs must be disconnected from the AC power.

- 8.1 Connect all equipment AC power input lines together and connect them to the H.V. lead of the hi-pot tester. Connect the RETURN lead of the hi-pot tester to the frame on which the drive and other auxiliary equipment are mounted.

8.2 The hi-pot tester must have an automatic ramp-up to the test voltage and an automatic ramp-down to zero voltage.

Note: If the hi-pot tester does not have automatic ramping, then the hi-pot output must be manually increased to the test voltage and then manually reduced to zero. This procedure must be followed for each machine to be tested. A suggested hi-pot tester is Slaughter Model 2550.

CAUTION! Instantly applying the hi-pot voltage will cause irreversible damage to the drive, which will void the warranty.

FIGURE 15 – TYPICAL HI-POT TEST SETUP

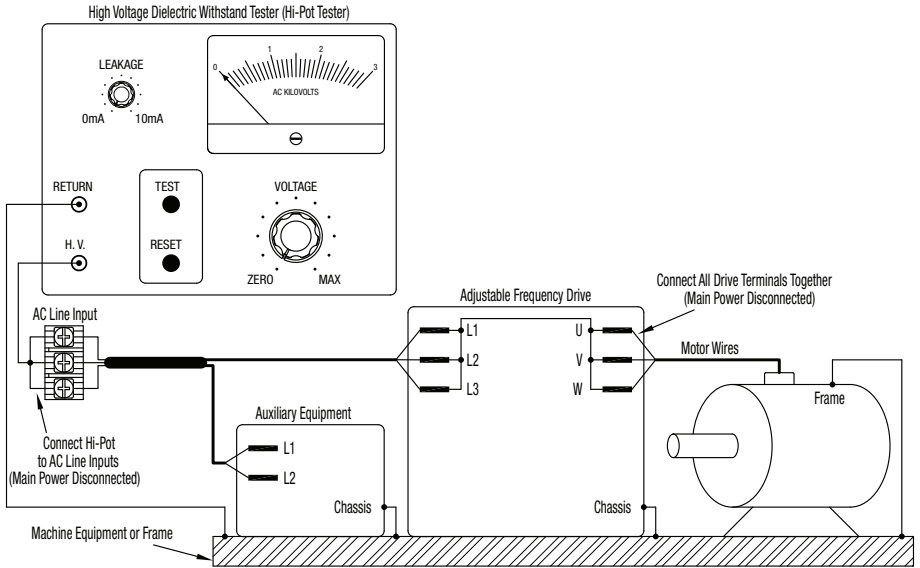

9 DRIVE OPERATION

Before operating the drive, read Section 9.2, for instructions on the Digital Keypad Operation. See Figure 2, on page 10, for the keypad layout.

The 4-digit display can indicate various functions of the drive: Set Frequency, Motor RPM, Output Current and Voltage, Custom Units, Function Numbers, Function Codes or Values, and Fault Codes. See Section 9.4, on page 30.

See Section 9.3, on pages 22 – 29, for information on programming the drive. If an error message appears while programming the drive, see Section 9.5, on page 31.

9.1 START-UP PROCEDURE – After the drive has been properly setup and all connections completed, the start-up procedure can begin. If the AC power has been properly brought to the drive, the LEDs will indicate the drive's status, as described in Section 11, on page 41. See Section 9.4, on page 30, for the Digital Readout Codes.









To start the drive, press the RUN Key. The motor will begin to accelerate to the Set Frequency. The factory set frequency is 05.00 Hz.

9.2 KEYPAD DESCRIPTION – The Keypad has eight (8) keys, which are used to program drive functions, as described in Table 6, on page 22. The eight (8) LEDs provide indication of the drive's

operational status, as described in Section 11, on page 41. A Main Speed Potentiometer is also provided to set the Drive Frequency (Function No. 2.00 set to "0001"). See Figure 2, on page 10.

Note: To avoid damage, never operate the keypad with a screwdriver or other sharp-ended tool.

TABLE 6 – KEYPAD DESCRIPTION

Key	Description
	Starts or Stops the drive
	Changes motor direction.
	Up Key: Increases Output Frequency, Set Frequency, Function Number Value, and Code setting.
	Down Key: Decreases Output Frequency, Set Frequency, Function Number Value, and Code setting.
	Factory programmed to function as a Jog Key. When the key is pressed, it toggles between Run Mode and Jog Mode (the "JOG/REM" LED will illuminate and the display will show the Jog Frequency Setting (see Function No. 3.13)). If the key is reprogrammed for Local/Remote Operation (see Function No. 2.02), the key is used to toggle between Local (Keypad) or Remote Signal Operation (the "LCL/REM" LED will illuminate).* <i>*Optional IODA or Modbus is required for Local/Remote Operation.</i>
	Used to enter Program Mode and Display Mode. If the key is pressed while Set Frequency is displayed, the previously entered Function Number will be shown. If the key is pressed while Function Number is displayed, the Set Frequency will be shown. When more than one display function is enabled, the key is used to toggle between displays. See Figure 22, on page 29.
	Left Shift / Reset Key: Moves the changeable digit or Resets the drive to clear a fault.
	Reads or Enters a Function Number's Value or Code setting. The key is also used to read or enter the frequency setting.

9.3 FLOW CHARTS FOR IMPORTANT PROGRAMMING FUNCTIONS – See Figures 16 – 22, on pages 23 – 29, for flow charts to program important functions. The flow charts also serve as a guide to understand the programming procedure.

Note: See Table 7, on page 30, for a description of the Digital Readout Codes.

FIGURE 16 – FLOW CHART TO PROGRAM THE DRIVE FOR 50 Hz MOTORS

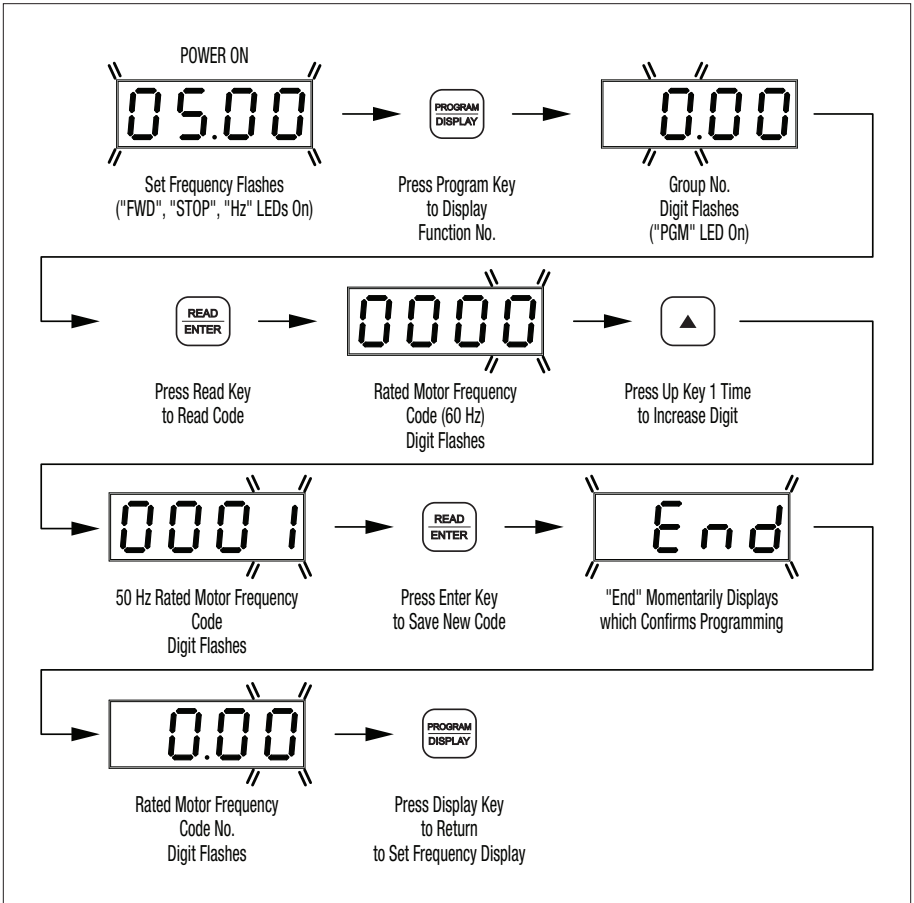
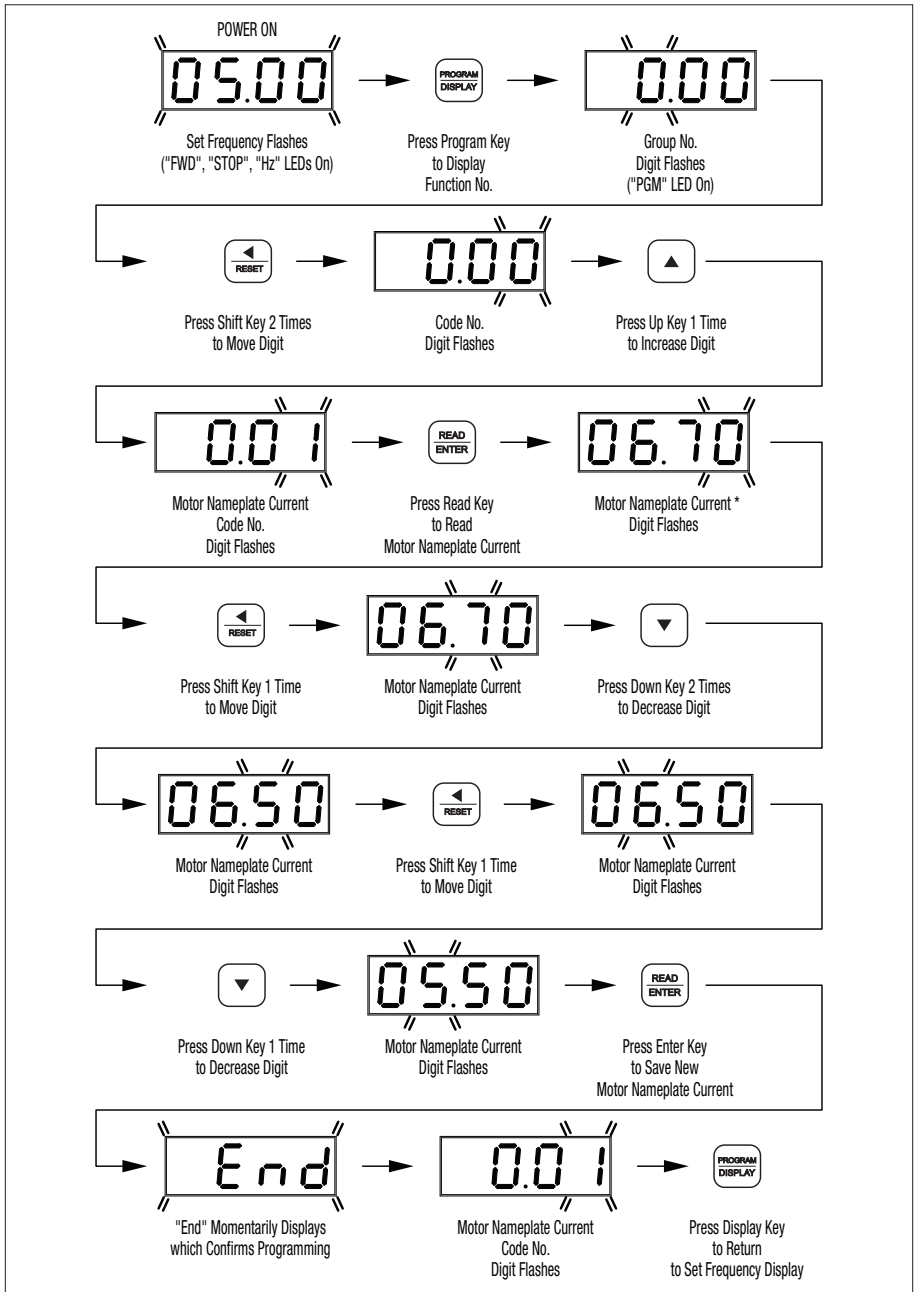
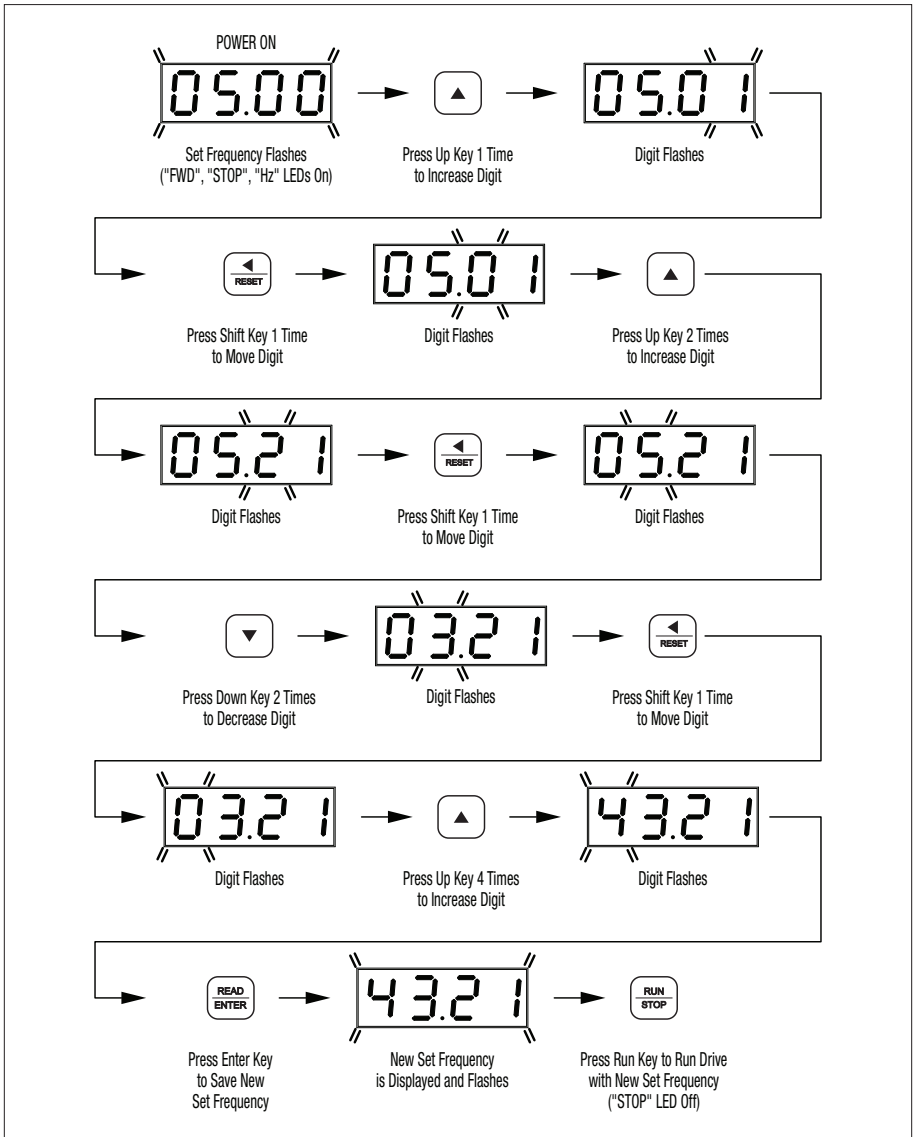

FIGURE 17 – FLOW CHART TO PROGRAM MOTOR CURRENT FROM 6.7 AMPS TO 5.5 AMPS



*For Models KBDA-27D, 29, the factory setting of Motor Nameplate Current (Function No. 0.01) is 6.7 Amps. See Table 3, on page 10, for the factory setting of Function No. 0.01 for all other models.

FIGURE 18 – FLOW CHART TO CHANGE SET FREQUENCY FROM 5.00 Hz TO 43.21 Hz (DRIVE IN THE STOP MODE)*



**If Function No. 2.01 is set to "0000", frequency change requires "ENTER". Throughout this sequence you must proceed to the next step within 20 seconds, before the "Press Enter Key" step, or the display will revert to "05.00". The new value will be stored in Function No. 3.00.*

FIGURE 19 – FLOW CHART TO PROGRAM ACCEL TIME FROM 1.5 SECONDS TO 120 SECONDS

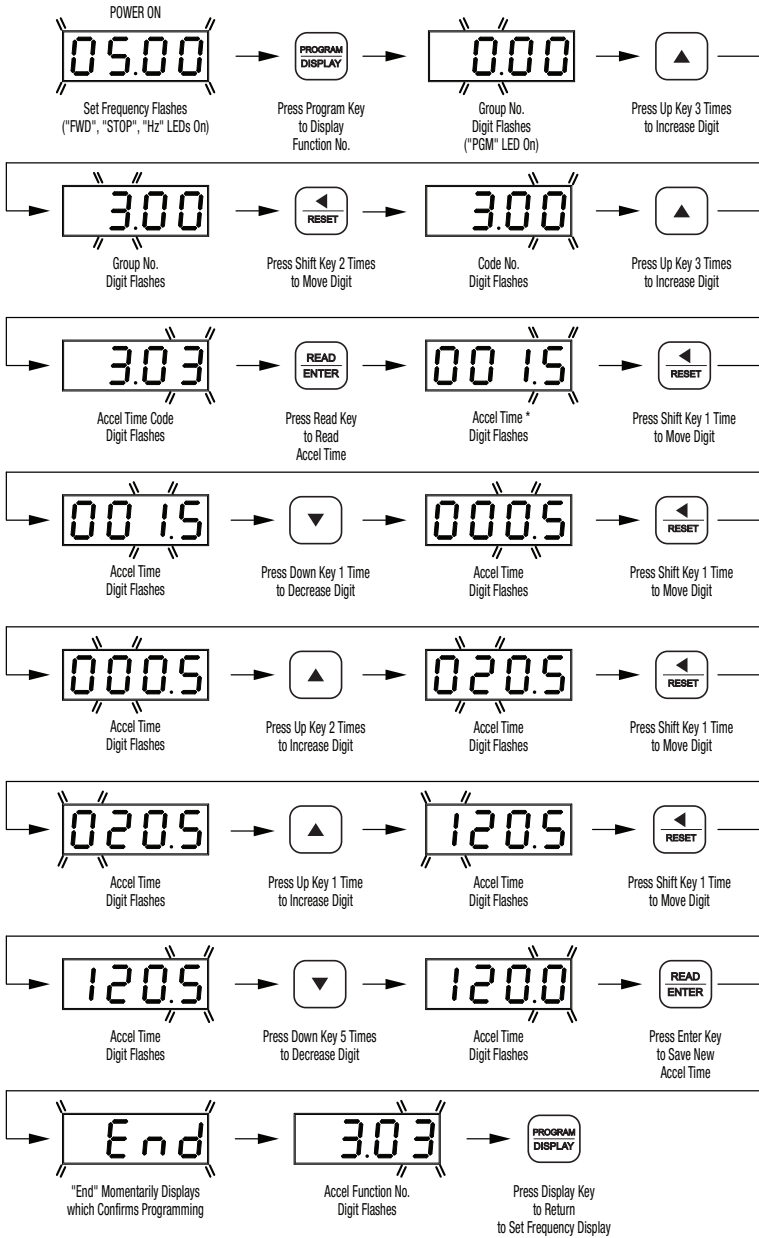

*The factory setting of Accel Time (Function No. 3.03) is "1.5" seconds. The minimum setting of Accel is 0.1 seconds, therefore, the left digits must be changed first since an Accel setting of 000.0 is not allowed.

FIGURE 20 – FLOW CHART TO PROGRAM THE DRIVE TO DISPLAY MOTOR RPM

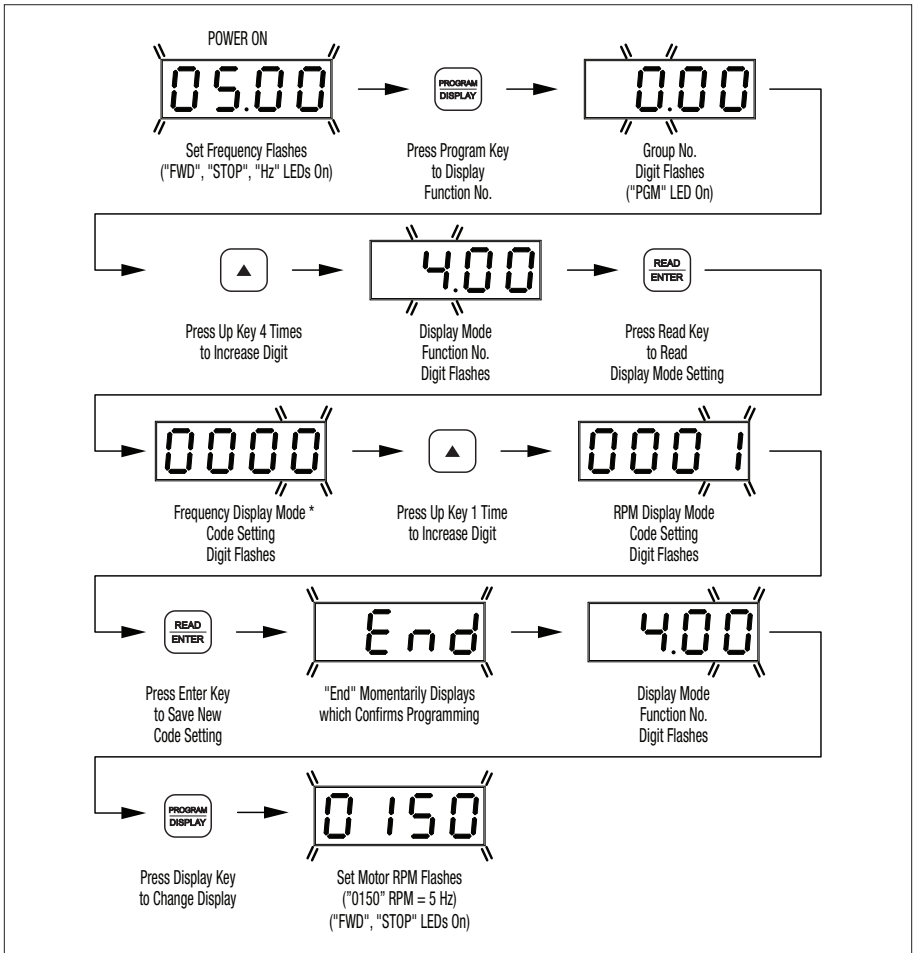

*The factory setting of Display Mode (Function No. 4.00) is Frequency ("0000").

FIGURE 21 – FLOW CHART TO PROGRAM THE DRIVE TO DISPLAY CUSTOM UNITS “012.0”

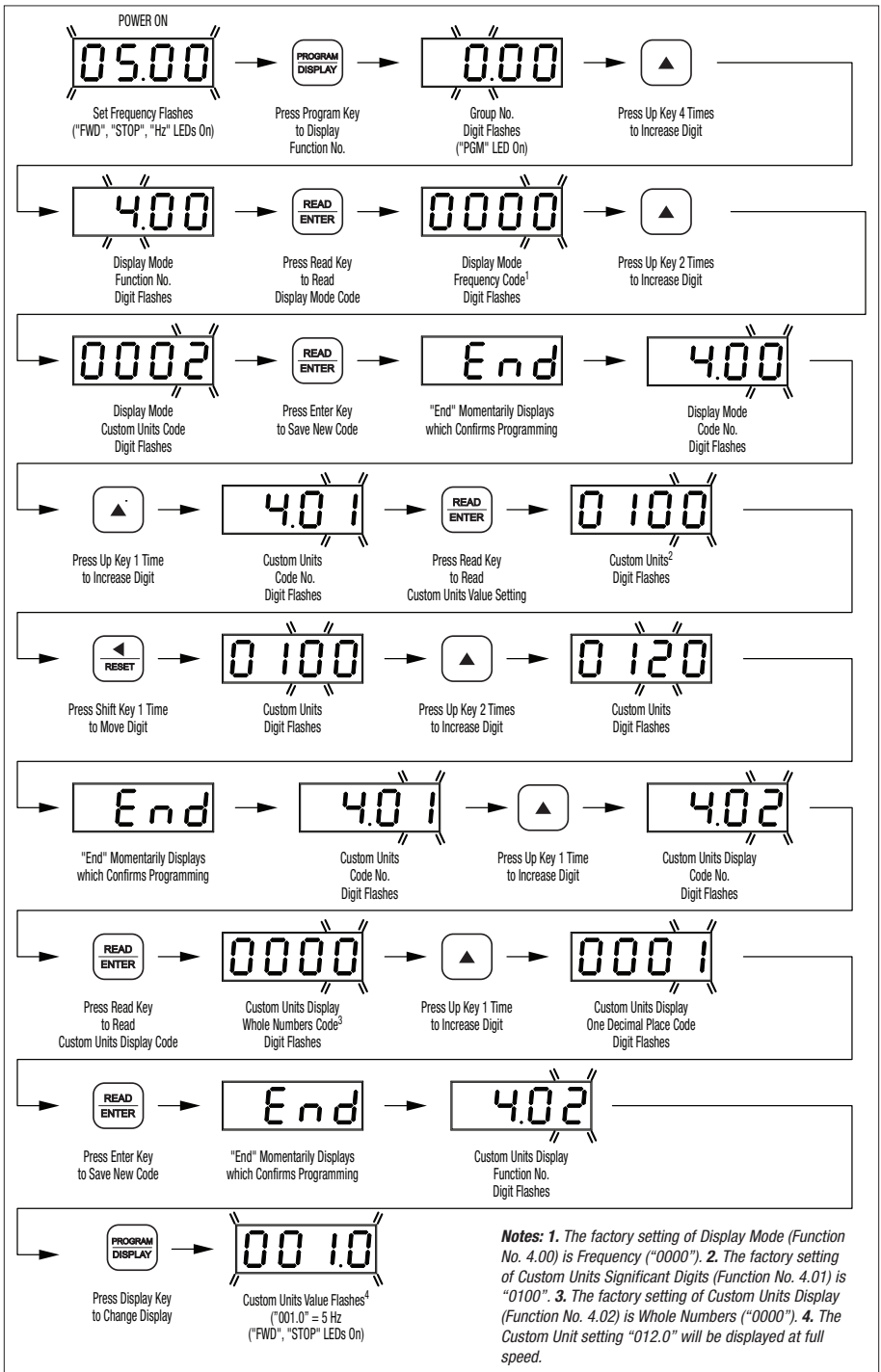
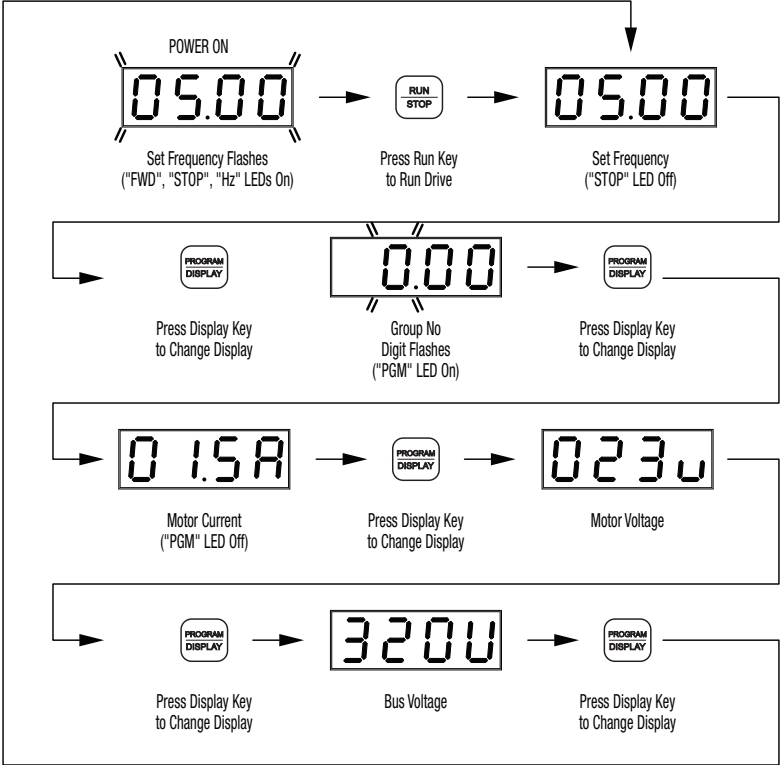

FIGURE 22 – FLOW CHART SHOWING MOTOR CURRENT, MOTOR VOLTAGE, AND BUS VOLTAGE ADDED TO THE BASIC DISPLAY*



*Function Nos. 4.04 – 4.06 set to "0001".

9.4 **4-DIGIT DISPLAY** – The 4-digit display provides readout of drive status, operating parameters, and faults. See Table 7 for the Digital Readout Codes displayed and their descriptions.



WARNING! Do not depend on the LEDs or the 4-Digit Display to no longer be illuminated as a guaranteed power off condition. Be sure the main power switch or

TABLE 7 – DIGITAL READOUT CODES

Display	Description	Display	Description
	Drive Stopped – Indicates that the drive is in the Stop Mode. Function No. 4.03 set to “0001”.		Parameter Changed – Momentarily flashes. Indicates that a parameter has been successfully changed.
	Function No. Example – A Function No. consists of a Group No. (digits on the left side of the decimal point) and a Group Code No. (digits on the right side of the decimal point).		Motor Current Display – When the display is set to show Motor Current, the format will be “XX.XA”. Function No. 4.04 set to “0001”.
	Motor Voltage Display – When the display is set to show Motor Voltage, the format will be “XXXU”. Function No. 4.05 set to “0001”.		Bus Voltage Display – When the display is set to show Bus Voltage, the format will be “XXXU”. Function No. 4.06 set to “0001”.
	Low Voltage Trip – Indicates that the AC line input voltage is below the Undervoltage Trip Point specified in Table 2, on page 9.		Low Voltage Recovery – Indicates that a Low Voltage Trip occurred and the AC line input voltage has returned to within the operating range specified in Table 2, on page 9.
	Overvoltage Trip – Indicates that the AC line input voltage is above the Overvoltage Trip Point specified in Table 2, on page 9.		Overvoltage Recovery – Indicates that an Overvoltage Trip occurred and the AC line input voltage has returned to within the operating range specified in Table 2, on page 9.
	Overload Trip (I²t Timeout) – Indicates that the motor has been overloaded for an extended period of time.		External Fault Trip – Indicates that an external fault has occurred at one of the MFITs of the IODA. Function Nos. 7.00 – 7.06 set to “0008”.
	Current Source Trip – Indicates that the current signal output (from the IODA) has been opened.		Short Circuit Fault – Indicates that the drive detected a short circuit at the motor (phase-to-phase).
	AC Line Phase Loss Detection – Indicates that the drive has detected a loss of one of the phases in the 3-phase AC line input applied to Models KBDA-29*, 45, 48.		Data Enter Error – Indicates that the drive is in the Program Mode and a non-valid parameter change has been attempted.
	Keypad Communication Error – Indicates that the keypad failed to initialize when the drive is powered up. This is an abnormal condition – contact our Sales Department.		Flash Memory Error – Indicates that a flash memory error on the drive has occurred. This is an abnormal condition – contact our Sales Department.
	IODA Error – Indicates that the drive has lost communication with the IODA.		

*Model KBDA-29: when used on 3-phase AC line input set for 7.0 Amps or higher (3 HP (2.25 kW)).

circuit breaker is in the “OFF” position before servicing the drive.

9.5 FAULT RECOVERY – The drive monitors many faults. See Function No. 1.05, on page 33, for restarting the drive after a fault has been cleared. See Section 9.4, on page 30, for the Digital Readout Codes. See Section 11, on page 41, for descriptions of the Diagnostic LEDs. See Appendix A, on page 42, for IODA faults.

Drive Faults – Undervoltage (“–LU–”), Overvoltage (“–OU–”), Short Circuit at the motor (phase-to-phase) (“–SC–”), I^2t or $I+t$ Fault (“OL–t”), and Phase Loss Detection (Models KBDA-29*, 45, 48 only) (“–PL–”).

*When used on 3-phase AC line input set for 7.0 Amps or higher (3 HP (2.25 kW)).

10 PROGRAMMABLE FUNCTION SUMMARY LIST

All functions have been factory set, as shown in the tables on pages 32 – 40. *The Detailed Programmable Function List (Part No. A42035) is available – contact our Sales Department.*

Programming Mode – When the drive is put into the Programming Mode (see Figure 23), a Function No. will be displayed. A Function No. consists of a Group No. (digits on the left side of the decimal point) and a Group No. Code (digits on the right side of the decimal point). The digits can be changed using the Up and Down Keys. The Left Shift Key is used to move the changeable digit.

When the READ Key is pressed, either a Code or Value will be displayed. Codes have specific descriptions. Values have numeric ranges.

Application Note – The programming of the drive can be performed without a motor connected. On drives with 3-phase AC line input requirements, the programming can be performed with single-phase AC line input. The drive’s Phase Loss Detection will not trip the drive without the motor connected.

To program multiple drives, the optional DownLoad Module™ (Part No. 9582) can be used to upload the drive program and facilitate downloading it to multiple drives.

FIGURE 23 – FUNCTION NO. DESCRIPTION

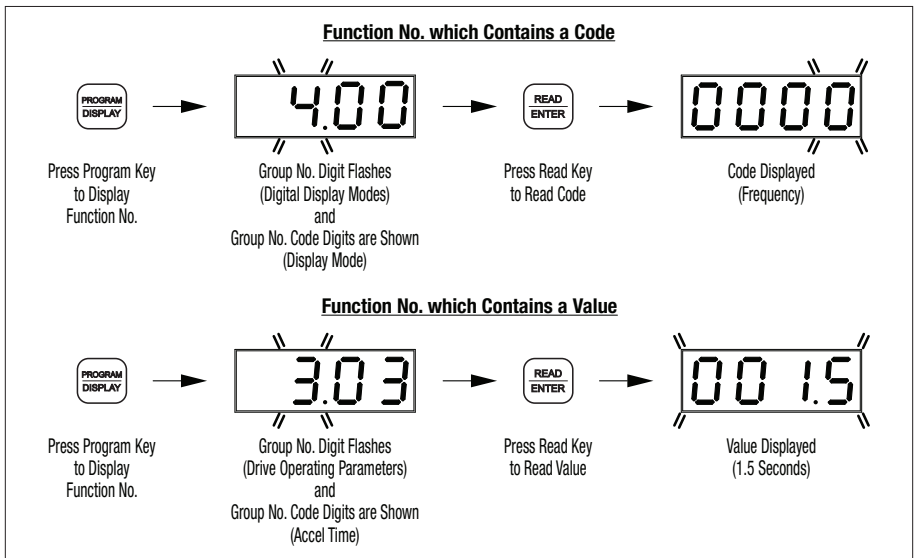

KBDA PROGRAMMABLE FUNCTION SUMMARY LIST (REV. 100.1)

PROGRAMMABLE FUNCTION GROUPS

Function Group No.	Description
0	Motor and Drive Parameters
1	Run/Stop Mode
2	Frequency Control
3	Drive Operating Parameters
4	Digital Display Modes
5	Onboard Multi-Function Output Relay Operating Mode
6	Drive Status and Reset
7	Multi-Function Input Terminals ⁽¹⁾
8	Multi-Function Output Relays and Output Signal Operation ⁽¹⁾
9	Analog Input Signal Operation ⁽¹⁾
10	Communication Mode ⁽²⁾
11	Reserved Functions

Note: (1) IODA Option Board required. (2) DIAC Option Board required.

FUNCTION GROUP 0 – MOTOR AND DRIVE PARAMETERS

Function No.	Description	Range/Code	Factory Setting
0.00*	Rated Motor Frequency (Hz)	0000: 60 Hz 0001: 50 Hz 0002: Special (Set by Function No. 0.05)	0000
0.01*	Motor Nameplate Current (Amps)	—	(1)
0.02*	Motor Type	0000: Inverter Duty, TEFC 0001: External Fan Cooled	0000
0.03*	Torque Mode	0000: Constant Torque (Machinery) 0001: Variable Torque (HVAC)	0000
0.04*	GFCI Operation ⁽²⁾	0000: GFCI Operation Disabled 0001: GFCI Operation with Standard GFCI 0002: GFCI Operation with Sensitive GFCI	0000
0.05*	Motor Frequency (Hz) ^{(3), (4)}	30 – 240	60, 50
0.06*	Motor Nameplate Voltage (% Drive Output) ⁽⁵⁾	0 – 100.0	100 ⁽⁶⁾

Notes: (1) Factory Setting is the drive rated output current. See Table 3, on page 10. This function is used to enter the Motor Nameplate Rated Current, which allows proper operation of the I^2t Motor Overload Protection. (2) GFCI operation overrides the Switching Frequency set by Function No. 3.15. (3) When the drive is set for 50 Hz motors (Function No. 0.00 set to “0001”), the Motor Frequency factory setting will automatically reset to 50 Hz. (4) The Motor Frequency for standard 50 Hz or 60 Hz motors is set by Function No. 0.00. For custom motors (e.g., 100 Hz) set Function No. 0.00 to “0002” and Function No. 0.05 to the Motor Nameplate Rated Frequency. (5) This function is used for motors with non-standard nameplate rated voltage (e.g., 80 Volts AC). (6) The factory set output of the drive is 100% of the AC line input voltage. In 60 Hz Mode (Function No. 0.00 set to “0000”) the drive output will be 230 Volts, maximum, for 230 Volt motors and 460 Volts, maximum, for 460 Volt Motors. In 50 Hz Mode (Function No. 0.00 set to “0001”) the drive output will be 220 Volts, maximum, for 220 Volt motors and 400 Volts, maximum, for 400 Volt Motors.

* Functions which can only be changed while the drive is in the Stop Mode.

FUNCTION GROUP 1 – RUN/STOP MODE

Function No.	Description	Range/Code	Factory Setting
1.00*	Run/Stop-Forward/Reverse Control	0000: Keypad 0001: External Contacts ⁽¹⁾ 0002: Communication ⁽²⁾	0000
1.01*	Forward/Reverse Control	0000: Instant Reverse 0001: Stop Command Must be Given Prior to Reverse Command 0002: Reverse Command Disabled 0003: Forward Command Disabled	0000
1.02*	Motor Direction	0000: Forward 0001: Reverse	0000
1.03*	Start Command	0000: Accelerates to Last Set Frequency 0001: Accelerates to Lower Frequency Limit (See Function No. 3.01)	0000
1.04*	Start Mode	0000: Spin Start 0001: Stop Before Restart	0000
1.05*	Auto/Manual Start Mode	0000: Manual Start Mode 0001: Manual Start with Ride-Through (Set by Function No. 1.06) 0002: Auto Start After Undervoltage Fault Clears 0003: Auto Start All Faults (Except Short Circuit Fault) ⁽³⁾ 0004: Auto Start All Faults (Except I ² t , I•t, and Short Circuit Faults)	0000
1.06*	Ride-Through Time (Seconds)	0.0 – 2.0	0.5
1.07*	Number of Restart Attempts	0 – 10	3
1.08*	Auto Start Delay Time (Seconds)	0 – 240	0
1.09*	Stop Mode	0000: Regenerate-to-Stop 0001: Coast-to-Stop 0002: Regeneration with Injection Brake-to-Stop (Set by Function Nos. 1.11 – 1.13)	0000
1.10*	Holding Torque in Stop Mode (%)	0 – 10	1
1.11	Injection Brake Start Frequency (Hz)	0.00 – 240.0	0.00
1.12	Injection Brake Level (%)	0 – 30	0
1.13	Injection Brake Time (Seconds)	0.0 – 25.5	0.0

Notes: (1) IODA Option Board required. (2) DIAC Option Board required. (3) For Auto Start, Function No. 1.07 must be set to greater than "0".

* Functions which can only be changed while the drive is in the Stop Mode.

FUNCTION GROUP 2 – FREQUENCY CONTROL

Function No.	Description	Code	Factory Setting
2.00*	Frequency Control	0000: Keypad 0001: Built-In Potentiometer 0002: Analog Signal 1 ⁽¹⁾ 0003: Analog Signal 2 ⁽¹⁾ 0004: Communication ⁽²⁾ 0005: Up/Down Using MFITs ⁽¹⁾	0000
2.01*	Up Key, Down Key Operation Mode	0000: Frequency Change Requires Enter Command 0001: Direct Frequency Change 0002: Keypad Disable	0000
2.02*	Jog-Local/Remote ^{(3),(4)}	0000: Jog Enabled 0001: Jog Disabled 0002: Jog Disabled; Local/Remote Enabled (Keypad Operation) ⁽¹⁾ 0003: Jog Disabled; Local/Remote Enabled (Built-In Speed Pot Operation) ⁽¹⁾	0000

Notes: (1) IODA Option Board required. (2) DIAC Option Board required. (3) See Jog Mode (Function No. 3.12), Jog Frequency (Function No. 3.13), and Jog Accel/Decel Time (Function No. 3.14). (4) The Jog function can be reprogrammed for Local/Remote (LCL/REM) Operation. When in Remote Mode Operation, the “JOG/REM” LED will flash.

* Functions which can only be changed while the drive is in the Stop Mode.

FUNCTION GROUP 3 – DRIVE OPERATING PARAMETERS

Function No.	Description	Range/Code	Factory Setting
3.00	Stored Set Frequency (Hz)	0.00 – 240.0	5.00
3.01	Lower Frequency Limit (Hz)	0.00 – 240.0	0.00
3.02	Upper Frequency Limit (Hz) ⁽¹⁾	0.00 – 240.0	60.0, 50.0
3.03	Accel Time (Seconds) ⁽²⁾	0.1 – 180.0	1.5
3.04	Decel Time (Seconds) ⁽²⁾	0.3 – 180.0	1.5
3.05	S-Curve Time Accel (Seconds) ⁽²⁾	0.0 – 30.0	0.0
3.06	S-Curve Time Decel (Seconds) ⁽²⁾	0.0 – 30.0	0.0
3.07*	Skip Frequency (Hz)	0.00 – 240.0	0.00
3.08*	Skip Frequency Bandwidth (± Hz)	0.00 – 2.00	0.00
3.09*	Motor Overload Protection	0000: I^2t with Current Limit 0001: $I \cdot t$ with Current Limit	0000
3.10*	$I \cdot t$ with Current Limit Trip Time (Seconds)	1.0 – 20.0	6.0
3.11	Boost Value (%)	0.0 – 28.0	7.0
3.12*	Jog Mode	0000: Momentary 0001: Latching	0000
3.13	Jog Frequency (Hz)	0.00 – 240.0	5.00
3.14	Jog Accel/Decel Time (Seconds)	0.3 – 10.0	1.0
3.15*	Switching Frequency (kHz)	0000: 8 0001: 10 0002: 12	0000
3.16	Flux Vector Compensation (%)	0.0 – 10.0	5.0

Notes: (1) When the drive is set for 50 Hz motors (Function No. 0.00 set to “0001”), the Upper Frequency Limit factory setting will automatically reset to 50 Hz. (2) Time set for Function Nos. 3.03 and 3.04 must be equal to or greater than the time set for Function Nos. 3.05 and 3.06, respectively.

* Functions which can only be changed while the drive is in the Stop Mode.

FUNCTION GROUP 4 – DIGITAL DISPLAY MODES

Function No.	Description	Range/Code	Factory Setting
4.00	Display Mode	0000: Frequency 0001: RPM ⁽¹⁾ 0002: Custom Units	0000
4.01	Custom Units Significant Digits	0 – 9999	100
4.02	Custom Units Display	0000: Whole Numbers 0001: One Decimal Place 0002: Two Decimal Places 0003: Three Decimal Places	0000
4.03	Display in Stop Mode	0000: Displays Last Run Setting 0001: Displays “StoP” 0002: Displays “0000”	0000
4.04	Motor Current Display ^{(2), (3)}	0000: Disabled 0001: Enabled	0000
4.05	Motor Voltage Display ^{(2), (3)}	0000: Disabled 0001: Enabled	0000
4.06	Bus Voltage Display ^{(2), (3)}	0000: Disabled 0001: Enabled	0000

Notes: (1) Based on 4-pole motor. (2) The Display Key is used to toggle between displays. See Figure 22, on page 29. (3) If Motor Current Display is enabled, the display will show “XX.XA”. If Motor Voltage Display is enabled, the display will show “XXXu”. If Bus Voltage Display is enabled, the display will show “XXXU”.

FUNCTION GROUP 5 – ONBOARD MULTI-FUNCTION OUTPUT RELAY OPERATING MODE

Function No.	Description	Range/Code	Factory Setting
5.00	Relay Operation Mode	0000: Run 0001: Fault ⁽¹⁾ 0002: Target Frequency (Function No. 5.01 ± Function No. 5.02) 0003: Frequency Threshold Level (> Function No. 5.01 – Function No. 5.02) ⁽²⁾ 0004: Frequency Threshold Level (< Function No. 5.01 + Function No. 5.02) ⁽³⁾ 0005: I ² t or I•t Fault 0006: Load Loss (See Function No. 5.03)	0000
5.01	Frequency Reached (Hz)	0.00 – 240.0	0.00
5.02	Frequency Bandwidth (Hz)	0.00 – 30.00	1.00
5.03	Load Loss Threshold ⁽⁴⁾ (% Motor Current, set by 0.01)	25 – 90	60

Notes: (1) The Output Relay contacts will change state due to all Faults and Recovered Faults. (2) The relay will activate above the setting in Function No. 5.01 and deactivate below the setting in Function No. 5.01 minus the setting in Function No. 5.02. (3) The relay will activate below the setting in Function No. 5.01 and deactivate above the setting in Function 5.01 plus the setting in Function No. 5.02. (4) The Load Loss Threshold function is not functional during acceleration/deceleration or Stop Mode.

FUNCTION GROUP 6 – DRIVE STATUS AND RESET

Function No.	Description	Code	Factory Setting
6.00*	Software Version	—	—
6.01*	Drive Horsepower	—	—
6.02*	Fault Log 1	—	—
6.03*	Fault Log 2	—	—
6.04*	Fault Log 3	—	—
6.05**	Reset Drive to Factory Setting	1110: 50 Hz Operation 1111: 60 Hz Operation	0000

* Read only.

** Functions which can only be changed while the drive is in the Stop Mode.

FUNCTION GROUP 7 – MULTI-FUNCTION INPUT TERMINALS (IODA OPTION BOARD REQUIRED)

Function No.	Description	Range/Code	Factory Setting
7.00*	Multi-Function Input Terminal 1 ⁽¹⁾	0000: Preset Frequency Operation ⁽²⁾ 0001: Preset Frequency Operation ⁽²⁾	0000
7.01*	Multi-Function Input Terminal 2 ⁽¹⁾	0002: Preset Frequency Operation ⁽²⁾ 0003: Up Frequency Command (See Function No. 7.14) ⁽³⁾	0001
7.02*	Multi-Function Input Terminal 3 ⁽¹⁾	0004: Down Frequency Command (See Function No. 7.14) ⁽³⁾	0002
7.03*	Multi-Function Input Terminal 4 ⁽¹⁾	0005: Accel/Decel 2 (See Function No. 7.16) 0006: Forward/Stop Command ⁽⁴⁾	0009
7.04*	Multi-Function Input Terminal 5 ⁽¹⁾	0007: Reverse/Stop Command ⁽⁴⁾ 0008: External Fault (N.O. Contact)	0010
7.05*	Multi-Function Input Terminal 6 ⁽¹⁾	0009: Reset 0010: N.O. Start (2-Wire or 3-Wire Start/Stop) ⁽⁴⁾	0003
7.06*	Multi-Function Input Terminal 7 ⁽¹⁾	0011: N.C. Stop (3-Wire Start/Stop) ⁽⁴⁾ 0012: External Fault (N.C. Contact)	0004
7.07	Preset Frequency 1 (Hz)	0.00 – 240.0	5.00
7.08	Preset Frequency 2 (Hz)	0.00 – 240.0	10.00
7.09	Preset Frequency 3 (Hz)	0.00 – 240.0	20.00
7.10	Preset Frequency 4 (Hz)	0.00 – 240.0	25.00
7.11	Preset Frequency 5 (Hz)	0.00 – 240.0	30.00
7.12	Preset Frequency 6 (Hz)	0.00 – 240.0	35.00
7.13	Preset Frequency 7 (Hz)	0.00 – 240.0	40.00
7.14	Up/Down Frequency Control Mode	0000: Free-Running ⁽⁵⁾ 0001: Incremental Change (See Function No. 7.15)	0000
7.15	Increment of Up/Down Frequency (Hz)	0.01 – 30.00	1.00
7.16	Accel/Decel 2 Time (Seconds)	0.3 – 180.0	1.5

Note: (1) Each of the 7 Multi-Function Input Terminals can be programmed for any of the respective function codes (0000 – 0011).

(2) Preset Frequencies 1 – 7 are obtained by selecting a specific combination of 3 Multi-Function Input Terminals. The specific frequencies are programmed in Functions 7.07 – 7.13. **(3)** For Up/Down Frequency Commands (codes “0003” and “0004”), Frequency Control (Function No. 2.00) must be set to Up/Down Using MFITs (code “0005”). **(4)** For Forward/Reverse Stop Commands (codes “0006” and “0007”) and N.O. Start / N.C. Stop (codes “0010” and “0011”), Run/Stop-Forward/Reverse Control (Function No. 1.00) must be set to External Contacts (code “0001”). **(5)** The rate of change of the “UP” Control for frequency setting, using external contacts, is proportional to the Accel Time setting (3.03). The rate of change of the “DOWN” Control for frequency setting, using external contacts, is proportional to the Decel Time Setting (3.04).

*Functions which can only be changed while the drive is in the Stop Mode.

**FUNCTION GROUP 8 – MULTI-FUNCTION OUTPUT RELAYS AND
OUTPUT SIGNAL OPERATION (IODA OPTION BOARD REQUIRED)**

Function No.	Description	Range/Code	Factory Setting
8.00*	Multi-Function Output Relay 1 (Terms. 23 – 25)	0000: Run 0001: Fault ⁽¹⁾ 0002: Target Frequency (Function No. 8.04 ± Function No. 8.05)	0000
8.01*	Multi-Function Output Relay 2 (Terms. 26 – 28)	0003: Frequency Threshold Level (> Function No. 8.04 – Function No. 8.05) ⁽²⁾ 0004: Frequency Threshold Level (< Function No. 8.04 + Function No. 8.05) ⁽³⁾	0001
8.02*	Multi-Function Open Collector Output 1 (Terms. 11, 12)	0005: I ² t or I•t Fault 0006: Load Loss (See Function No. 5.03)	0002
8.03*	Multi-Function Open Collector Output 2 (Terms. 13, 14)	0007: External Fault 0008: Motor Overload ⁽⁴⁾	0004
8.04	Frequency Set Point (Hz)	0.00 – 240.0	0.00
8.05	Frequency Bandwidth (± Hz)	0.00 – 30.00	1.00
8.06	Analog Output 1 Mode (Terms. 15, 16) (0 – 5 VDC)	0000: Motor Frequency 0001: Set Frequency 0002: Motor Voltage 0003: Bus Voltage 0004: Motor Current	0000
8.07	Analog Output 1 Gain (%)	0 – 200	100
8.08	Analog Output 2 Mode (Terms. 17, 18) (See Function No. 8.09)	0000: Motor Frequency 0001: Set Frequency 0002: Motor Voltage 0003: Bus Voltage 0004: Motor Current	0000
8.09	Analog Output 2 Type ⁽⁵⁾	0000: 0 – 5 VDC 0001: 0 – 20 mA DC 0002: 4 – 20 mA DC	0000
8.10	Analog Output 2 Gain (%)	0 – 200	100

Notes: (1) The Multi-Function Output Relays and Open Collector Outputs will change state due to all Faults and Recovered Faults. (2) The relay will activate above the setting in 8.04 and deactivate below the setting of 8.04 – 8.05. (3) The relay will activate below the setting in 8.04 and deactivate above the setting of 8.04 + 8.05. (4) The Output Relay will change state when the I²t or I•t Timer starts. (5) Analog Output 2 Type: For 0 – 5 VDC (code “0000”), set Jumpers J2 and J3, on the IODA, to the “VOLT” Position (factory setting). For 0 – 20 mA DC (code “0001”) or 4 – 20 mA DC (code “0002”), set Jumpers J2 and J3, on the IODA, to the “CUR” position.

*Functions which can only be changed while the drive is in the Stop Mode.

**FUNCTION GROUP 9 – ANALOG INPUT SIGNAL OPERATION
(IODA OPTION BOARD REQUIRED)**

Function No.	Description	Range/Code	Factory Setting
9.00	Analog Input 1 Gain (%) ⁽¹⁾	0 – 500	100
9.01	Analog Input 1 Slope ⁽¹⁾	0000: Positive 0001: Negative	0000
9.02	Analog Input 1 Offset (%) ⁽¹⁾	0 – 100	0
9.03	Analog Input 1 Type ⁽¹⁾	0000: Unidirectional 0001: Bidirectional	0000
9.04	Analog Input 1 Response Time (mSec) ⁽¹⁾	2 – 100	2
9.05	Analog Input 2 Gain (%) ⁽²⁾	0 – 500	100
9.06	Analog Input 2 Slope ⁽²⁾	0000: Positive 0001: Negative	0000
9.07	Analog Input 2 Offset (%) ⁽²⁾	0 – 100	0
9.08	Analog Input 2 Type ⁽²⁾	0000: Analog Voltage or Current ⁽³⁾ 0001: PWM ⁽⁴⁾	0000
9.09	Analog Input 2 Response Time (mSec) ⁽²⁾	2 – 100	2

Notes: (1) For Analog Input 1 (Function Nos. 9.00 – 9.04), Frequency Control (Function No. 2.00) must be set to Analog Signal 1 (code “0002”). (2) For Analog Input 2 (Function Nos. 9.05 – 9.09), Frequency Control (Function No. 2.00) must be set to Analog Signal 2 (code “0003”). (3) For Current Signal Input, set Jumper J1, on the IODA, to the “CUR” position. (4) 0.15 – 1 kHz (0 – 100% duty cycle).

FUNCTION GROUP 10 – COMMUNICATION MODE (DIAC OPTION BOARD REQUIRED)

Function No.	Description	Range/Code	Factory Setting	
10.00*	Assigned Communication Station Number	1 – 247	30	
10.01*	Communications Watchdog Timer	0000: Disabled 0001: Enabled	0000	
10.02	Watchdog Timeout (Seconds)	0.50 – 2.00	0.50	
10.03	Operational Command	0	0: Stop 1: Run	—
		1	0: Forward 1: Reverse	
		2	0: N/A 1: Fault Reset	
		3	0: JOG-LCL/REM Command Off 1: JOG-LCL/REM Command On	
		4	0: N/A 1: Preset Frequency 1	
		5	0: N/A 1: Preset Frequency 2	
		6	0: N/A 1: Preset Frequency 3	
		7	0: N/A 1: Preset Frequency 4	
		8	0: N/A 1: Preset Frequency 5	
		9	0: N/A 1: Preset Frequency 6	
		10	0: N/A 1: Preset Frequency 7	
11 – 15	Reserved			

* Functions which can only be changed while the drive is in the Stop Mode.

**FUNCTION GROUP 10 – COMMUNICATION MODE
(DIAC OPTION BOARD REQUIRED) (Continued)**

Function No.	Description	Range/Code		Factory Setting
10.04	Drive Status	0	0: Stop 1: Run	—
		1	0: Forward 1: Reverse	
		2	0: Normal 1: Fault	
		3	0: JOG-LCL/REM Command Off 1: JOG-LCL/REM Command On	
		4	0: N/A 1: Preset Frequency 1	
		5	0: N/A 1: Preset Frequency 2	
		6	0: N/A 1: Preset Frequency 3	
		7	0: N/A 1: Preset Frequency 4	
		8	0: N/A 1: Preset Frequency 5	
		9	0: N/A 1: Preset Frequency 6	
		10	0: N/A 1: Preset Frequency 7	
		11	0: Jog Momentary Mode 1: Jog Latching Mode	
		12	Reserved	
		13	0: Local 1: Remote	
		14, 15	Reserved	
10.05	Drive Status Description	00	Normal Operation	—
		01	Short Circuit Trip	
		02	Current Limit	
		03	Current Limit Trip	
		04	Undervoltage Trip	
		05	Recovered Undervoltage Trip	
		06	Overvoltage Trip	
		07	Recovered Overvoltage Trip	
		08	Stop Mode	
		09	Flash Error	
		10	External Fault Trip (IODA)	
		11	IODA Error	
		12	Phase Loss Trip	
		13	Current Source Trip (IODA)	
10.06 **	Communications Error Count	—		—
10.07 **	Motor Voltage	—		—
10.08 **	Motor Current	—		—
10.09 **	Bus Voltage	—		—
10.10 **	Motor Frequency	—		—

** Read only.

FUNCTION GROUP 11 – RESERVED FUNCTIONS

Function No.	Description	Range/Code	Factory Setting
11.00 – 11.09	Reserved	—	—

TABLE 8 – MODEL SOFTWARE REVISION CODES (REV. 100.1)

The Programmable Function List, on Pages 32 – 40, is Applicable to the Following* Software Revision Codes

Model No.	Software Revision Code
KBDA-24D	29/1.02
KBDA-27D	35/1.02
KBDA-29	37/1.01
KBDA-45	38/1.01
KBDA-48	39/1.01

* Or higher.









11 DIAGNOSTIC LEDs

The drive contains 8 Status LEDs to provide indication of the drive's status and operating mode (Hz, PGM, LCL/REM, STOP, FWD, REV, OL, JOG/REM). See Table 9, for a description of the LEDs.



WARNING! Do not depend on the LEDs or the 4-Digit Display to no longer be illuminated as a guaranteed power off condition. Be sure the main power switch or circuit breaker is in the "OFF" position before servicing the drive.

TABLE 9 – LED DESCRIPTIONS

LED	Description
JOG  REM	Illuminates when Jog is selected. Flashes when the drive is set for Remote Signal Operation.
OL 	Illuminates when the drive is in Overload.
FWD 	Illuminates when the drive is in the Forward Direction.
REV 	Illuminates when the drive is in the Reverse Direction.
STOP 	Illuminates when the drive is in the Stop Mode.
Hz 	Illuminates when the display is set to show Output Frequency.
LCL/REM 	Illuminates when the JOG-LCL/REM Key is reprogrammed for Local (Keypad) and Remote Signal Operation.
PGM 	Illuminates when the drive is in the Program Mode.

APPENDIX A – OPTIONAL IODA INPUT/OUTPUT MULTI-FUNCTION BOARD

The IODA Input/Output Multi-Function Board provides a variety of functions, which include preset frequency, up/down frequency control, signal isolation, isolated output voltage for controlling auxiliary devices, open collector outputs, and output relay contacts. The IODA mounts on the drive's PC board with 2 snap-ins (located on the bottom of the mounting base) and 2 screws (provided). All of the IODA inputs and outputs are isolated from the AC line.

The IODA has a green power on LED (PWR) and a red status LED (STATUS), which are used to provide operational information of the IODA. See Table 10, below, for a description of the IODA status indicator LED. See Figure 24, on page 43, for the IODA layout. See Figure 25, on page 43, for the IODA Terminal Block TB1 Layout. See Table 11, on page 43, for the IODA Terminal Block TB1 Wire and Tightening Torque Specifications. See Table 12, on page 44, for the IODA Functions and Features. See Sections A1 – A7, on pages 45 – 49 describing the use of the IODA Multi-Function Input Terminals for Remote Operations. See Sections A8 – A12, on pages 49 – 54, for Other Functions and Features of the IODA.

Local/Remote Operation – When using the IODA with signal following, it may be appropriate to program the drive for Local/Remote Operation. In this mode, the drive frequency setting can be toggled between a process signal and the keypad using the JOG-LCL/REM Key. Set Jog-Local/Remote (Function No. 2.02) to Jog Disabled; Local/Remote Enabled (“0002”) to change the JOG-LCL/REM Key from Jog Operation to Local/Remote Operation.

IODA Faults – External Fault Trip (“EF-t”) indicates that a Multi-Function Input Terminal (Function Nos. 7.00 – 7.06 set to “0008”) has closed (and will change the state of the Multi-Function Output Relay Contacts and the Multi-Function Open Collectors (when Function Nos. 8.00 – 8.03 are set to “0007”). Current Source Trip (“CS-t”) indicates that the current signal output (from the IODA) has been opened. Communication Error (“Err4”) indicates that communication between the drive and the IODA has failed.



WARNING! Do not depend on the LEDs or the 4-Digit Display to no longer be illuminated as a guaranteed power off condition. Be sure the main power switch or circuit breaker is in the “OFF” position before servicing the drive.

TABLE 10 – IODA STATUS INDICATOR LED

Condition	Red STATUS LED
Normal Operation	Not Illuminated
Communication Error ¹	Flashes 1 Second On and 1 Second Off
Current Source Trip ²	Illuminated

Notes: 1. When a Communication Error occurs, the drive's 4-Digit Display will show “Err4”. 2. When a Current Source Trip occurs, the drive's 4-Digit Display will show “CS-t”.

FIGURE 24 – IODA LAYOUT (ALL MODELS)*

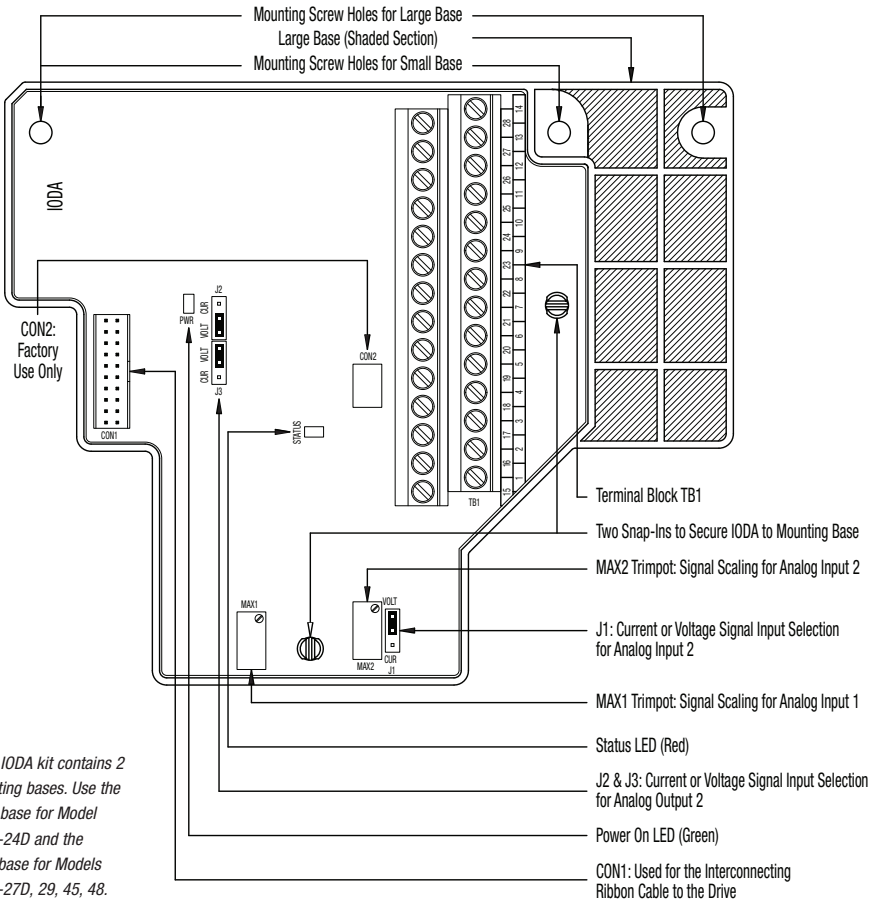

* The IODA kit contains 2 mounting bases. Use the small base for Model KBDA-24D and the large base for Models KBDA-27D, 29, 45, 48.

FIGURE 25 – IODA TERMINAL BLOCK TB1 LAYOUT

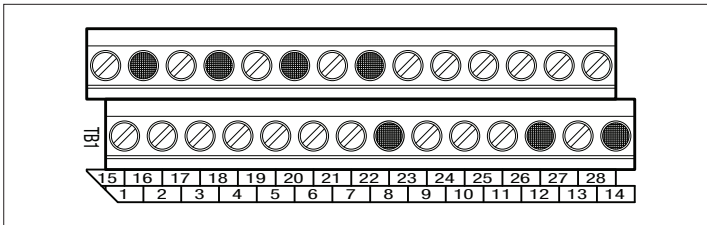

Common Terminals 8, 12, 14, 16, 18, 20, and 22 are all internally connected and are shown shaded.

TABLE 11 – IODA TERMINAL BLOCK TB1 WIRE AND TIGHTENING TORQUE SPECIFICATIONS

Maximum Wire Size (Cu)		Recommended Tightening Torque	
AWG	mm ²	in-lbs	kg-cm
16	1.3	6	7

TABLE 12 – IODA FUNCTIONS AND FEATURES

Multi-Function Input Terminal Codes	Terminal Assignment					
	Multi-Function Input Terminals ¹ (Digital Inputs)	Power Supply ²	Multi-Function Outputs ²	Analog Outputs ²	Analog Inputs ²	Relay Outputs ³
0000: Preset Frequency Operation ¹ 0001: Preset Frequency Operation ¹ 0002: Preset Frequency Operation ¹ 0003: Up Frequency Command (See Function No. 7.14) 0004: Down Frequency Command (See Function No. 7.14) 0005: Accel/Decel 2 (See Function No. 7.16) 0006: Forward/Stop Command 0007: Reverse/Stop Command 0008: External Fault 0009: Reset 0010: N.O. Start (2-Wire or 3-Wire Start/Stop) 0011: N.C. Stop (3-Wire Start/Stop)	1 – 7	8: Common 9: +5 Volts 10: –5 Volts	11: Open Collector 1 12: Common 13: Open Collector 2 14: Common	15: Analog Out 1 16: Common 17: Analog Out 2 18: Common	19: Analog In 1 20: Common 21: Analog In 2 22: Common	23: RY1 N.O. 24: RY1 Common 25: RY1 N.C. 26: RY2 N.O. 27: RY2 Common 28: RY2 N.C.

Notes: **1.** Multi-Function Input Terminals “1” – “7” can be programmed for: 7 Preset Frequencies*, Up or Down Frequency Command, Accel/Decel 2, Forward/Stop, Reverse/Stop, External Fault, Reset, and 2-Wire/3-Wire Start/Stop. **2.** Common Terminals 8, 12, 14, 16, 18, 20, and 22 are all internally wired together and can be used with any of the Multi-Function Input Terminals “1” – “7”. **3.** RY1 Common (Terminal 24) is the contact common only for Relay 1. RY2 Common (Terminal 27) is the contact common only for Relay 2.

*The 7 Preset Frequencies are obtained using a combination of Terminals 1, 2, 1+2, 3, 1+3, 2+3, 1+2+3.

A1. PRESET FREQUENCIES

The drive is factory programmed for 7 Preset Frequencies, which can be selected using remote switches or contacts connected to the Multi-Function Input Terminals “1” – “7”, as shown in Figure 26. See Table 13, for the Multi-Function Input Terminals to select for the preset frequencies. The Preset Frequencies can be changed from their factory settings by reprogramming Preset Frequencies 1 – 7 (Function Nos. 7.07 – 7.13). When the switch or contact is closed, the preset frequency is selected. In Figure 26, Multi-Function Input Terminals “1”, “2”, and “3” have been arbitrarily chosen. As an example, Function Nos. 7.04, 7.05, and 7.06 can also be programmed to use Multi-Function Input Terminals “5”, “6”, and “7”.

FIGURE 26 – PRESET FREQUENCY SELECTION SWITCH OR CONTACT CONNECTIONS AND FUNCTION SETTINGS

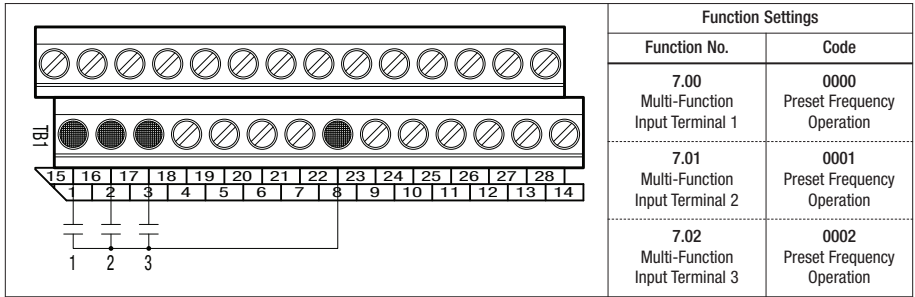

TABLE 13 – PRESET FREQUENCY SELECTION

Multi-Function Input Terminals to Select			Preset Frequency		
Terminal 1	Terminal 2	Terminal 3	No.	Function No.	Hz (Factory Setting)
•			1	7.07	5.00
	•		2	7.08	10.00
•	•		3	7.09	20.00
		•	4	7.10	25.00
•		•	5	7.11	30.00
	•	•	6	7.12	35.00
•	•	•	7	7.13	40.00

A2. UP/DOWN FREQUENCY COMMAND

The Multi-Function Input Terminals can be used for remote Up/Down Frequency control in lieu of the Keypad or the Built-In Potentiometer. Connect the normally open switches or contacts to any two respective Multi-Function Input Terminal (“1” – “7”). Connect the common of the switches or contacts to Terminal “8” (common). When the “Up” switch or contact is closed, the drive output frequency will increase. When the “Down” switch or contact is closed, the drive output frequency will decrease. See Figure 27, on page 46.

Set Frequency Control (Function No. 2.00) to Up/Down Using MFITs (“0005”). Set the respective Multi-Function Input Terminal (Function Nos. 7.00 – 7.06), which will be used for “Up”, to “0003”. Set the respective Multi-Function Input Terminal (Function Nos. 7.00 – 7.06), which will be used for “Down”, to “0004”. In Figure 27, on page 46, Multi-Function Input Terminals “4” and “5” have been arbitrarily chosen.

Also see Up/Down Frequency Control Mode (Function No. 7.14) to set the switch or contact mode for “Free Running” (Function No. 7.14 set to “0000” (factory setting)) or “Incremental Change” (Function No. 7.14 set to “0001”). In “Free Running” mode, the rate of change of the “UP” control is proportional to the Accel Time (Function No. 3.03) and the rate of change of the “Down” control is proportional to the Decel Time (Function No. 3.04). In “Incremental Change” mode, the rate of change of the “UP” or “Down” control is set by Function No. 7.15 (range is 0.01 – 30.00 Hz (factory set to 1.00 Hz)).

FIGURE 27 – UP/DOWN FREQUENCY CONTROL SWITCH OR CONTACT CONNECTIONS AND FUNCTION SETTINGS

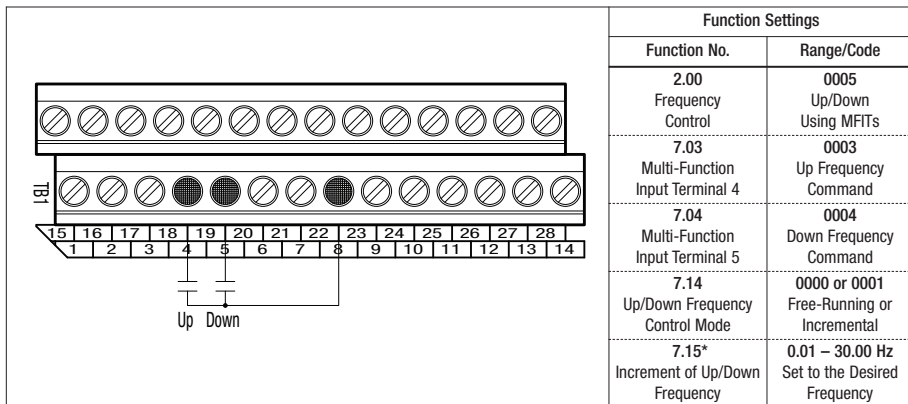

* Use with Function No. 7.14 code "0001" only.

A3. ACCEL/DECEL 2

The drive provides a secondary Accel/Decel Time setting, which can be remotely selected with a switch or contact connected to any Multi-Function Input Terminal "1" – "7", as shown in Figure 28.

Set the respective Multi-Function Input Terminal (Function Nos. 7.00 – 7.06) to Accel/Decel 2 ("0005"). The Accel/Decel 2 time is set in Function No. 7.16 (factory set to 1.5 seconds). When the switch or contact is closed, the Accel/Decel 2 setting is selected. Accel/Decel 2 overrides the Accel and Decel settings in Function Nos. 3.03 and 3.04. In Figure 28, Multi-Function Input Terminal "6" has been arbitrarily chosen.

FIGURE 28 – ACCEL/DECEL 2 SWITCH OR CONTACT CONNECTION AND FUNCTION SETTINGS

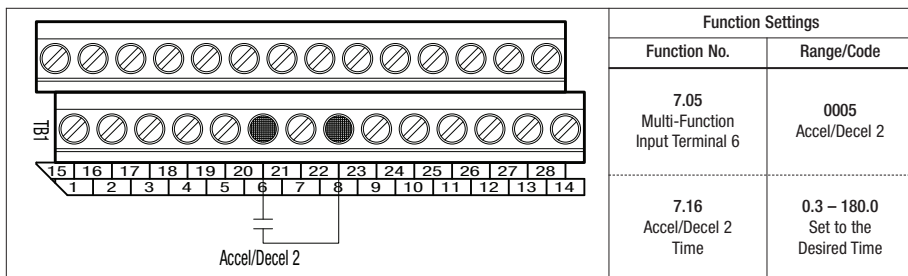

A4. FORWARD/STOP AND REVERSE/STOP COMMAND

The Multi-Function Input Terminals can be used for remote Forward/Stop and Reverse/Stop operation by connecting a switch or contact to any Multi-Function Input Terminal "1" – "7", as shown in Figure 29, on page 47. When the "Forward/Stop" switch or contact is closed, the drive will run in the forward direction and when the switch or contact is opened, the drive will stop. When the "Reverse/Stop" switch or contact is closed, the drive will run in the reverse direction and when the switch or contact is opened, the drive will stop.

Set Run/Stop-Forward/Reverse Control (Function No. 1.00) to External Contacts ("0001"). Set the respective Multi-Function Input Terminal (Function Nos. 7.00 – 7.06), which will be used for "Forward/Stop", to "0006". Set the respective Multi-Function Input Terminal (Function Nos. 7.00 – 7.06), which will be used for "Reverse/Stop", to "0007". In Figure 29, on page 47, Multi-Function Input Terminals "4" and "7" have been arbitrarily chosen.

FIGURE 29 – FORWARD/STOP-REVERSE/STOP SWITCH OR CONTACT CONNECTIONS AND FUNCTION SETTINGS

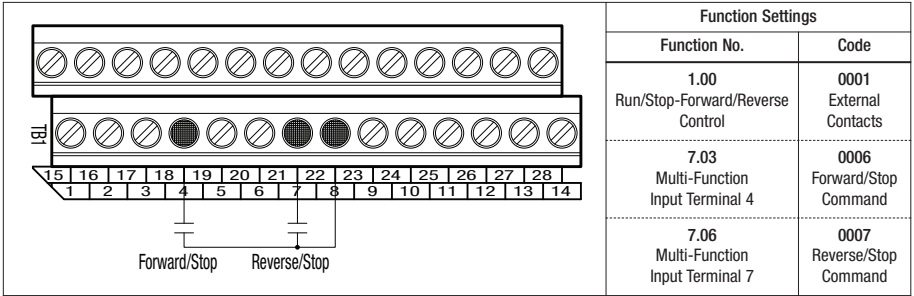

A5. EXTERNAL FAULT

The Multi-Function Input Terminals can be used to provide feedback to the drive when a fault condition occurs in auxiliary equipment. The connection to the Multi-Function Input Terminals is typically from a normally open relay, contact, or PLC, as shown in Figure 30. When the circuit is closed, the drive will “stop” and the display will show “EF-t”.

Set the respective Multi-Function Input Terminal (Function Nos. 7.00 – 7.06), which will be used for “External Fault”, to “0008”. In Figure 30, Multi-Function Input Terminal “5” has been arbitrarily chosen.

FIGURE 30 – EXTERNAL FAULT AUXILIARY EQUIPMENT SWITCH OR CONTACT CONNECTION AND FUNCTION SETTING

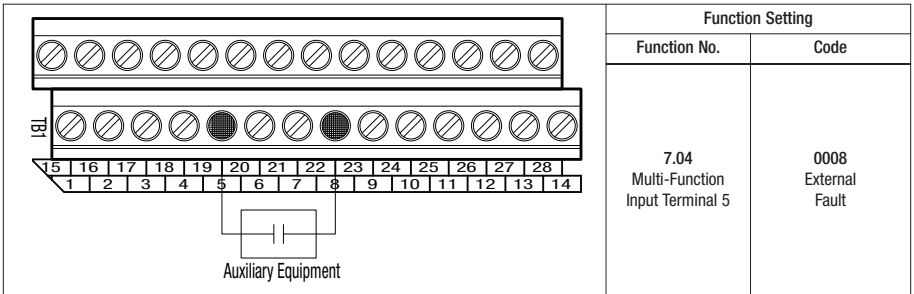

A6. RESET

The Multi-Function Input Terminals can be used to reset the drive, after a fault has been cleared, by connecting a switch or contact to any Multi-Function Input Terminal “1” – “7”, as shown in Figure 31.

Set the respective Multi-Function Input Terminal (Function Nos. 7.00 – 7.06), which will be used for “Reset”, to “0009”. In Figure 31, Multi-Function Input Terminal “4” has been arbitrarily chosen.

FIGURE 31 – RESET SWITCH OR CONTACT CONNECTION AND FUNCTION SETTING

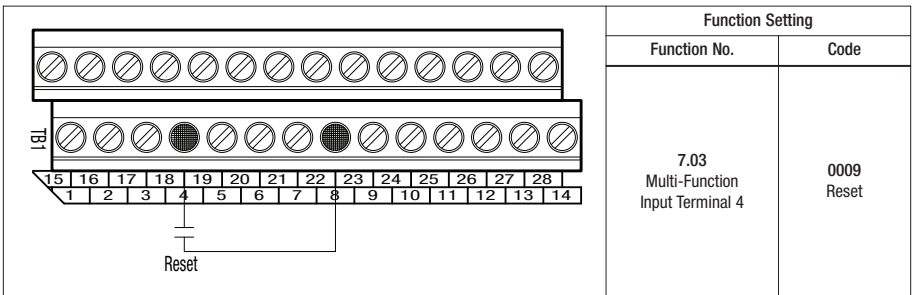

A7. 2-WIRE AND 3-WIRE START/STOP

A remote Start/Stop Switch or Contact can be used to start and stop the motor in lieu of the RUN/STOP Key on the Keypad. The Start/Stop Switch or Contact can be connected for 2-Wire or 3-Wire configuration, as described below.

2-WIRE START/STOP SWITCH OR CONTACT CONNECTION

2-Wire Start/Stop requires a maintained switch or contact. Connect the switch or contact to the respective Multi-Function Input Terminal “1” – “7” and to Terminal “8” (common), as shown on Figure 32.

Set Run/Stop-Forward/Reverse Control (Function No. 1.00) to External Contacts (“0001”). Set the respective Multi-Function Input Terminal (Function Nos. 7.00 – 7.06), which will be used for “Normally Open Start”, to “0010”. In Figure 32, Multi-Function Input Terminal “3” has been arbitrarily chosen.

Note: Function code “0011” should not be programmed when using 2-Wire Start/Stop.

FIGURE 32 – 2-WIRE START/STOP SWITCH OR CONTACT CONNECTION AND FUNCTION SETTINGS

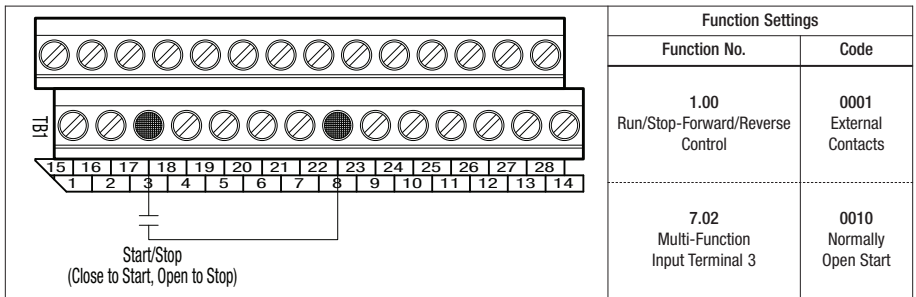

3-WIRE START/STOP SWITCH OR CONTACT CONNECTION

3-Wire Start/Stop requires momentary switches or contacts. Connect the normally open side of the switch or contact to the respective Multi-Function Input Terminal “1” – “7”. Connect the normally closed side of the switch or contact to the other respective Multi-Function Input Terminal “1” – “7”. Connect the common of the switch or contacts to Terminal “8”. See Figure 33, on page 49.

Set Run/Stop-Forward/Reverse Control (Function No. 1.00) to External Contacts (“0001”). Set the respective Multi-Function Input Terminal (Function Nos. 7.00 – 7.06), which will be used for “Normally Open Start”, to “0010”. Set the respective Multi-Function Input Terminal (Function Nos. 7.00 – 7.06), which will be used for “Normally Closed Stop”, to “0011”. In Figure 33, on page 49, Multi-Function Input Terminals “1” and “2” have been arbitrarily chosen.

Notes: 1. When an MFIT (Terminal 2) is assigned code “0011”, the MFIT (Terminal 1) assigned code “0010” automatically changes from maintained to momentary operation. 2. When using 3-Wire Start/Stop, “Stop” will override “Start”, even if the Start Switch or Contact is kept in the “Start position.”

FIGURE 33 – 3-WIRE START/STOP SWITCH OR CONTACT CONNECTION AND FUNCTION SETTINGS

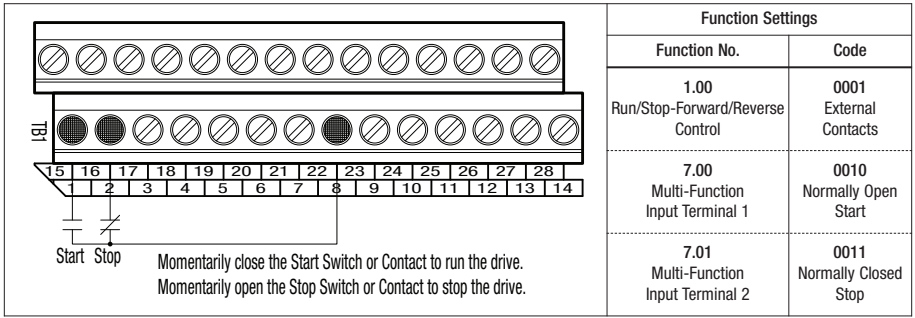

OTHER FUNCTIONS AND FEATURES OF THE IODA

A8. SIGNAL FOLLOWING

An analog voltage (unidirectional or bidirectional), current, or PWM signal input can be used to control motor speed in lieu of the Keypad or the Built-In Potentiometer. The drive output will linearly follow the signal input. The inputs can be programmed for the desired gain, slope, offset, and response time. See Analog Input Signal Operation (Function Group 9).

Analog Input 1 – Connect the signal input to Terminal “19” and the common to Terminal “20”, as shown in Figure 34. See settings for Analog Input 1 (Function Nos. 9.00 – 9.04). Set Frequency Control (Function No. 2.00) to Analog Input 1 (“0002”). For unidirectional voltage input, set Analog Input 1 Type (Function No. 9.03) to Unidirectional (“0000” (factory setting)). For bidirectional voltage input, set Function No. 9.03 to Bidirectional (“0001”). See Table 14, on page 50, for Analog Input 1 electrical ratings.

If the Analog Input 1 signal is higher than 5 Volts, use Trimpot MAX1 to attenuate it. Apply the maximum signal input and set the drive for full speed output and observe the display. Rotate Trimpot MAX1 counterclockwise until the drive output frequency begins to drop. Then rotate Trimpot MAX1 clockwise until the display returns to the maximum output frequency.

FIGURE 34 – ANALOG INPUT 1 SIGNAL VOLTAGE FOLLOWING CONNECTION AND FUNCTION SETTINGS

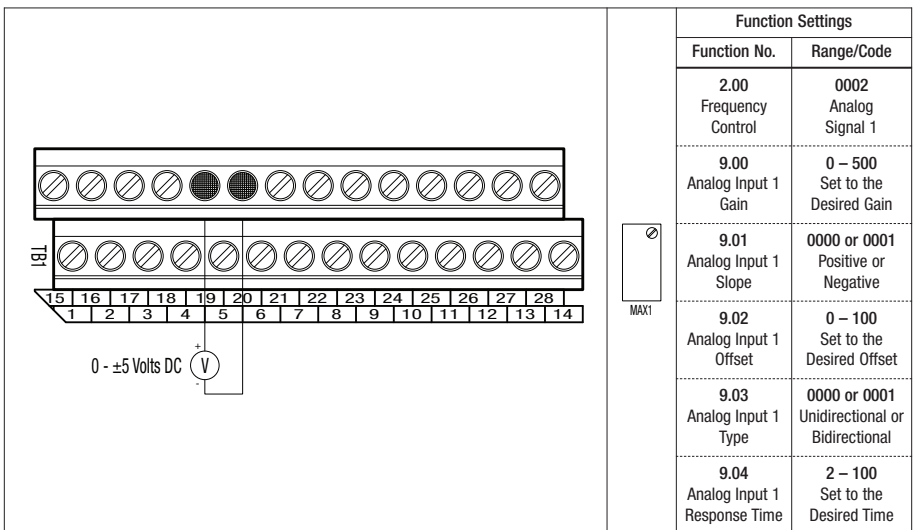

TABLE 14 – ANALOG INPUT 1 ELECTRICAL RATINGS

Parameter	Specification	Factory setting
Voltage Range (Volts DC)	0 – ±5	0 – 5
MAX1 Scaling Trimpot Range (Volts DC)	0 – 24	5

Analog Input 2 – Connect the signal input to Terminal “21” and the common to Terminal “22”, as shown in Figure 35. See settings for Analog Input 2 (Function Nos. 9.05 – 9.09). Set Frequency Control (Function No. 2.00) to Analog Input 2 (“0003”). For voltage input, set Jumper J1 to the “VOLT” position and set Analog Input 2 Type (Function No. 9.08) to Analog Voltage or Current (“0000”) (factory setting). For current input, set Jumper J1 to the “CUR” position and set Analog Input 2 Type (Function No. 9.08) to Analog Voltage or Current (“0000”) (factory setting). For PWM input set Jumper J1 to the “VOLT” position and set Analog Input 2 Type (Function No. 9.08) to PWM (“0001”). See Table 15 for Analog Input 2 electrical ratings.

If the Analog Input 2 signal is higher than the input signals specified in Table 15, use Trimpot MAX2 to attenuate it. Apply the maximum signal input and set the drive for full speed output and observe the display. Rotate Trimpot MAX2 counterclockwise until the drive output frequency begins to drop. Then rotate Trimpot MAX2 clockwise until the display returns to the maximum output frequency.

FIGURE 35 – ANALOG INPUT 2 SIGNAL CURRENT FOLLOWING CONNECTION AND FUNCTION SETTINGS

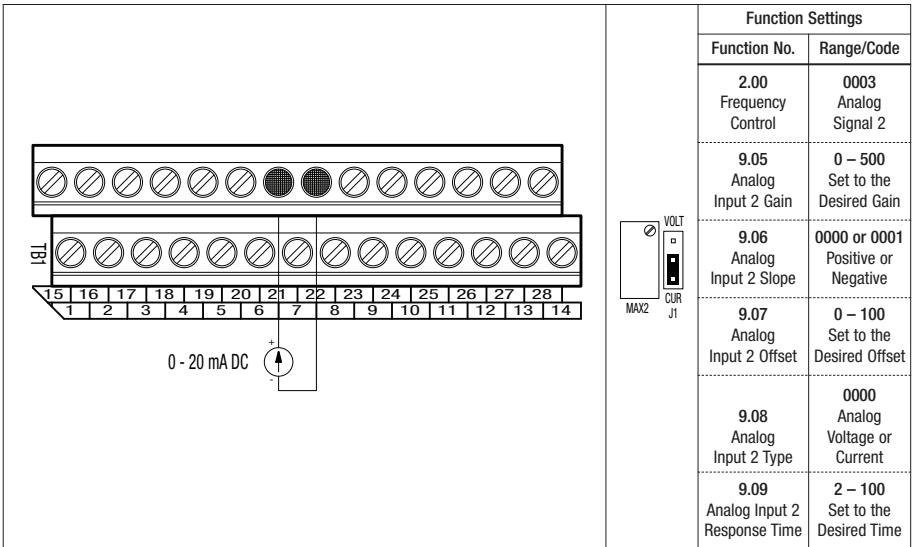

TABLE 15 – ANALOG INPUT 2 ELECTRICAL RATINGS

Parameter	Specification	Factory setting
Voltage Range (Volts DC)	0 – 5	0 – 5
MAX2 Scaling Trimpot Range (Volts DC)	0 – 24	5
Current Range (mA DC)	0 – 20*	—
Input Impedance for Current Mode (Ω)	270	—
PWM (kHz, Duty Cycle)	0.15 – 1, 0 – 100	—

* If using 4 – 20 mA DC signal input, the offset setting in Function No. 9.07 must be increased from “0%” (factory setting) to “20%”. Set Jumper J1 to the “CUR” position.

A9. ANALOG SIGNAL OUTPUT

Two analog signal outputs are provided, which will linearly follow the parameter programmed in Analog Output 1 Mode (Function No. 8.06) and Analog Output 2 Mode (Function No 8.08). They can be used to monitor Motor Frequency, Set Frequency, Motor Voltage, Bus Voltage, and Motor Current. See Table 16, for the Analog Outputs 1 and 2 Electrical Ratings.

Analog Output 1 – Connect the auxiliary device signal input to Terminal “15” and the common to Terminal “16”, as shown in Figure 36. Set Analog Output 1 Mode (Function No. 8.06) for the desired parameter to be monitored (factory set to Motor Frequency (“0000”). Set Analog Output 1 Gain (Function No. 8.07) for the desired signal gain (factory set to 100%). Analog Output 1 provides a 0 – 5 Volt DC signal output.

Analog Output 2 – Connect the auxiliary device signal input to Terminal “17” and the common to Terminal “18”, as shown in Figure 36. Set Analog Output 2 Mode (Function No. 8.08) for the desired parameter to be monitored (factory set to Motor Frequency (“0000”). Set Analog Output 2 Type (Function No. 8.09) to (“0000”) (factory setting) for 0 – 5 Volt DC output. Set Analog Output 2 Type (Function No. 8.09) to “0001” for 0 – 20 mA DC output. Set Analog Output 2 Type (Function No. 8.09) to “0002” for 4 – 20 mA DC output. Set Analog Output 2 Gain (Function No. 8.10) for the desired signal gain (factory set to 100%).

FIGURE 36 – ANALOG OUTPUTS 1 AND 2 CONNECTIONS AND FUNCTION SETTINGS

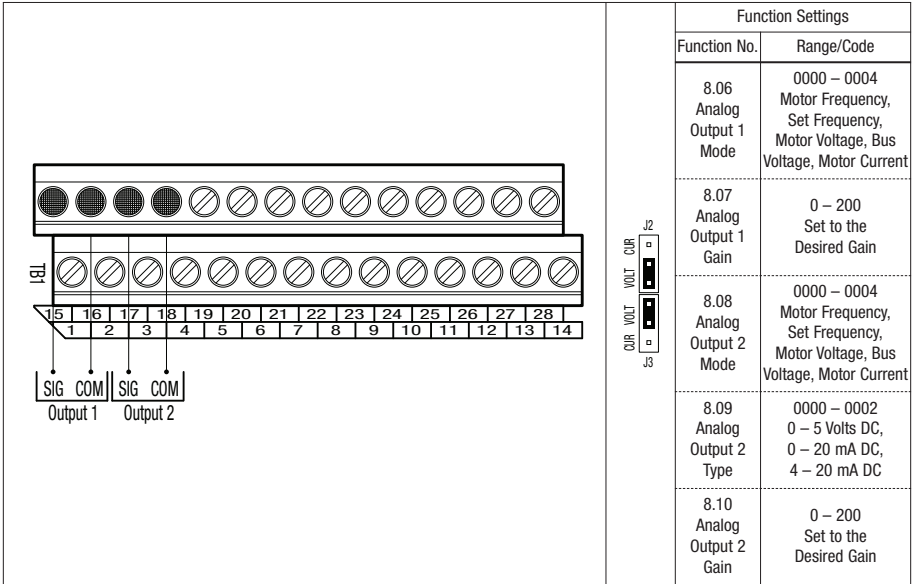

TABLE 16 – ANALOG OUTPUTS 1 AND 2 ELECTRICAL RATINGS

Parameter	Specification	Factory setting
Analog Outputs 1 and 2 Voltage Range (Volts DC)	0 – 5	0 – 5
Analog Output 2 Current Range (mA DC)	0 – 20, 4 – 20	—
Analog Output 2 Impedance for Current Mode (Ω)	150	—

A10. REMOTE MAIN SPEED POTENTIOMETER

A remote Main Speed Potentiometer (5 kΩ) can be used in lieu of the Keypad or the Built-In Potentiometer. The Main Speed Potentiometer can be connected for bidirectional, forward, or reverse motor speed control, as described on page 52.

BIDIRECTIONAL MOTOR OPERATION (Use Analog Input 1 Only)

Connect the potentiometer to Terminals “9” (+5 Volts), “19” (Analog Input 1), and “10” (-5 Volts), as shown in Figure 37. Set Frequency Control (Function No. 2.00) to Analog Input 1 (“0002”). In this mode, the remote potentiometer is set for zero speed at 50% rotation. Rotating the potentiometer clockwise will increase motor frequency in the forward direction. Rotating the potentiometer counter-clockwise will increase motor frequency in the reverse direction.

FIGURE 37 – BIDIRECTIONAL MOTOR OPERATION MAIN SPEED POTENTIOMETER CONNECTION AND FUNCTION SETTING

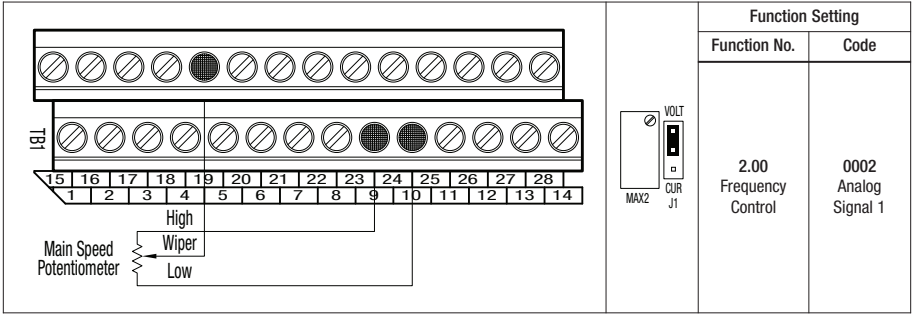

FORWARD MOTOR OPERATION

Analog Input 1 – Connect the potentiometer to Terminals “9” (+5 Volts), “19” (Analog Input 1), and “20” (Common). Set Frequency Control (Function No. 2.00) to Analog Input 1 (“0002”).

Analog Input 2 – Connect the potentiometer to Terminals “9” (+5 Volts), “21” (Analog Input 2), and “22” (Common). Set Frequency Control (Function No. 2.00) to Analog Input 2 (“0003”).

REVERSE MOTOR OPERATION

Analog Input 1 – Connect the potentiometer to Terminals “10” (-5 Volts), “19” (Analog Input 1), and “20” (Common). Set Frequency Control (Function No. 2.00) to Analog Input 1 (“0002”).

Analog Input 2 – Connect the potentiometer to Terminals “10” (-5 Volts), “21” (Analog Input 2), and “22” (Common). Set Frequency Control (Function No. 2.00) to Analog Input 2 (“0003”).

A11. MULTI-FUNCTION OUTPUT RELAYS

Two Multi-Function Output Relays are provided, which can be programmed for Run, Fault, Target Frequency, Frequency Threshold Level (> 8.04 – 8.05), Frequency Threshold Level (< 8.04 + 8.05), I²t or I-t Fault, Load Loss, External Fault, and Motor Overload. Relay 1 is factory programmed to operate as a “Run” Relay (Function No. 8.00 set to “0000” (factory setting)). Relay 2 is factory programmed to operate as a “Fault” Relay (Function No. 8.01 set to “0001” (factory setting)). The maximum allowable contact load current is 2 Amps. See Figure 38, on page 53.

Note: If the drive “stops”, due to an External Fault Trip (“EF-t”), which indicates that a Multi-Function Input Terminal (Function Nos. 7.00 – 7.06 set to “0008”) has closed, the Multi-Function Output Relay Contacts will change state (when Function No. 8.00 or 8.01 is set to “0007”).

Multi-Function Output Relay 1 Contacts

- Normally Open (N.O.) Contact:** TB1 Terminal “23”.
- Common (COM):** TB1 Terminal “24” (contact common for Relay 1 only).
- Normally Closed (N.C.) Contact:** TB1 Terminal “25”.

Multi-Function Output Relay 2 Contacts

Normally Open (N.O.) Contact: TB1 Terminal “26”.

Common (COM): TB1 Terminal “27” (contact common for Relay 2 only).

FIGURE 38 – MULTI-FUNCTION OUTPUT RELAY CONTACTS CONNECTIONS AND FUNCTION SETTINGS

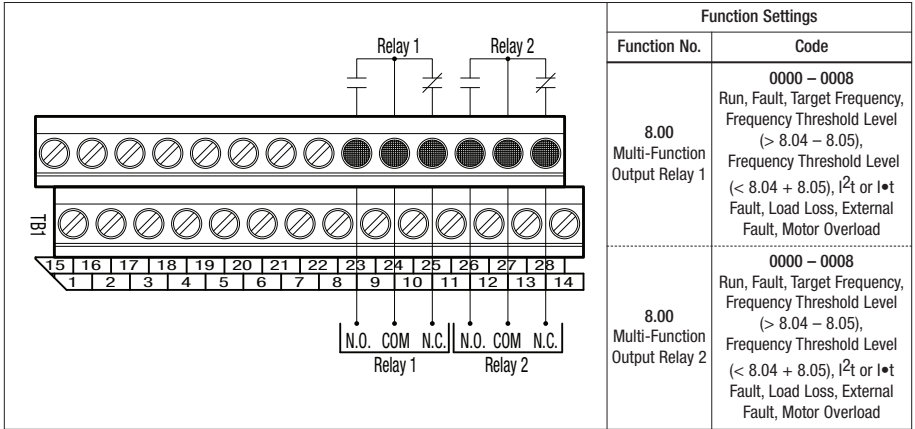

Normally Closed (N.C.) Contact: TB1 Terminal “28”.

A12. MULTI-FUNCTION OPEN COLLECTOR OUTPUTS

Two Open Collector Outputs are provided, which can be programmed for Run, Fault, Target Frequency, Frequency Threshold Level (> 8.04 – 8.05), Frequency Threshold Level (< 8.04 + 8.05), I²t or I•t Fault, Load Loss, External Fault, and Motor Overload. Open Collector Output 1 is factory programmed to operate as a Target Frequency indicator (Function No. 8.02 set to “0002” (factory setting)). Open Collector Output 2 is factory programmed to operate as a Frequency Threshold Level (< 8.04 + 8.05) indicator (Function No. 8.03 set to “0004” (factory setting)). See Figure 39, on page 54. See Table 17, on page 54, for the Multi-Function Open Collector Output electrical Ratings.

Multi-Function Open Collector Output 1

Collector (O.C.): TB1 Terminal “11”.

Emitter (COM): TB1 Terminal “12” (internal circuit common).

Multi-Function Open Collector Output 2

Collector (O.C.): TB1 Terminal “13”.

Emitter (COM): TB1 Terminal “14” (internal circuit common).

FIGURE 39 – MULTI-FUNCTION OPEN COLLECTOR CONNECTIONS AND FUNCTION SETTINGS

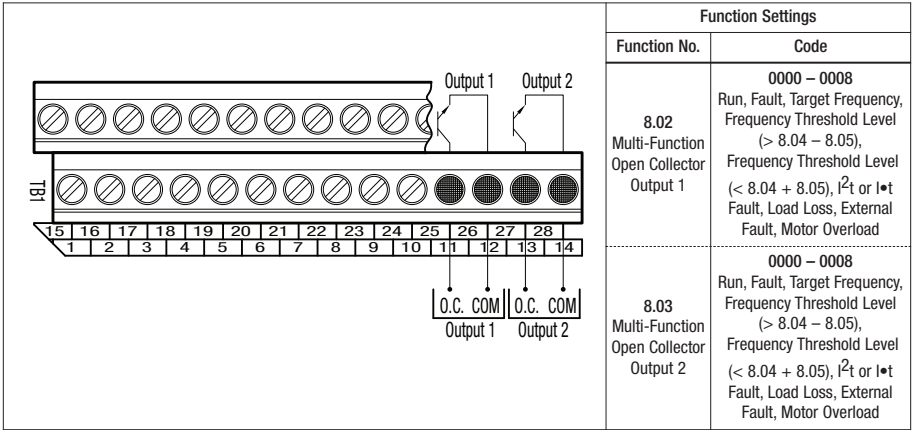

TABLE 17 – MULTI-FUNCTION OPEN COLLECTOR OUTPUTS ELECTRICAL RATINGS

Parameter	Specification	Factory setting
Maximum Voltage (Volts DC)	24	—
Maximum Load Current (mA DC)	60	0 – 20
Minimum External Resistance (Ω)	400	—

- NOTES -

LIMITED WARRANTY

For a period of 18 months from the date of original purchase, KB Electronics, Inc. will repair or replace without charge, devices which our examination proves to be defective in material or workmanship. This warranty is valid if the unit has not been tampered with by unauthorized persons, misused, abused, or improperly installed and has been used in accordance with the instructions and/or ratings supplied. The foregoing is in lieu of any other warranty or guarantee, expressed or implied. KB Electronics, Inc. is not responsible for any expense, including installation and removal, inconvenience, or consequential damage, including injury to any person, caused by items of our manufacture or sale. Some states do not allow certain exclusions or limitations found in this warranty and therefore they may not apply to you. In any event, the total liability of KB Electronics, Inc., under any circumstance, shall not exceed the full purchase price of this product. (rev 2/2000)

COPYRIGHT © 2015 KB Electronics, Inc.

All rights reserved. In accordance with the United States Copyright Act of 1976, no part of this publication may be reproduced in any form or by any means without permission in writing from KB Electronics, Inc. (8/2002)



KB ELECTRONICS, INC.

12095 NW 39th Street, Coral Springs, FL 33065-2516 • (954) 346-4900 • FAX (954) 346-3377
Outside Florida Call Toll Free (800) 221-6570 Ext. 1132 • info@kbelectronics.com
www.kbelectronics.com