

**KBPW-240D Installation and Operation Manual (Rev. A)
Supplemental Information**

 **WARNING!** Disconnect main power when making connections to the drive.

The following information and instructions are to be used as a supplement to the KBPW-240D Installation and Operation Manual Rev. A (Part No. A40360). The manual must be read and understood before attempting to operate this control.

The PC board has been upgraded to include provision for normally open or normally closed stop contacts and to connect an Enable switch. The General Performance Specifications have not changed.

Jumper J6 (Stop Switch type "NO" or "NC" Selection) and Jumper J7 (Enable Selection) have been added. Enable terminals have been added to Terminal Block TB3. Also, Figures 7A and 10A have been added.

Changes to Table of Contents, on Page ii

Figure	Page
7A Remote 3-Wire Start/Stop Switch with Normally Closed Stop Contact	8
10A Enable Switch Connection	9

Changes to Wiring, Section III-G, on Page 8

G. Remote Start/Stop Switch Connections

The control is supplied with a prewired Start/Stop Switch with a normally open "NO" stop contact. Jumper J6 is factory set to the "NO" position.

For remote 3-wire Start/Stop Switch with a normally closed "NC" stop contact, connect the switch as shown in Figure 7A, below. Set Jumper J6 to the "NC" position.

**Figure 7A
Remote 3-Wire Start/Stop Switch
with Normally Closed Stop Contact**

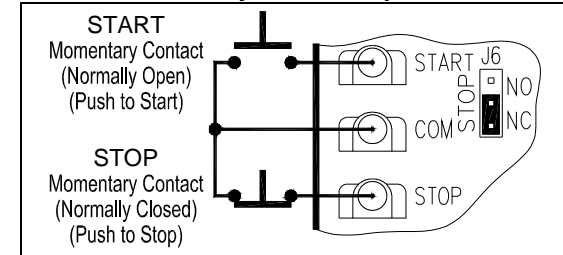

Changes to Wiring, Section III-K, on Page 9

K. Enable Connection

Wire the Enable contact to Terminals "EN1" and "EN2" of Terminal Block TB3 as shown in Figure 10A, below.

The Enable is used to electronically start and stop the control. When the Enable contact is closed, the control will accelerate to the Main Speed Potentiometer setting. When the Enable contact is opened, the control will coast to stop.

Note: The contact must be isolated from the AC line and Jumper J7 must be removed.

**Figure 10A
Enable Switch Connection**

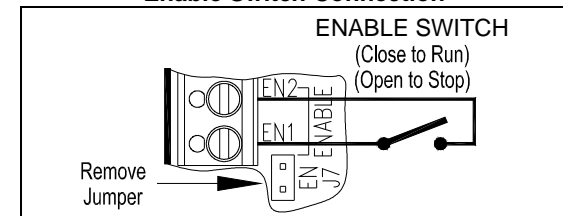

INSTALLATION AND OPERATING INSTRUCTIONS

MODEL KBPW-240D

KB Part No. 8401 (Black Case) • Part No. 8402 (White Case)

NEMA 4X, IP-65

PWM DC Motor Speed Control For PM and Shunt Wound Motors
Rated 7.5 Amps DC, 11.5 Amps AC @ 115/230 VAC

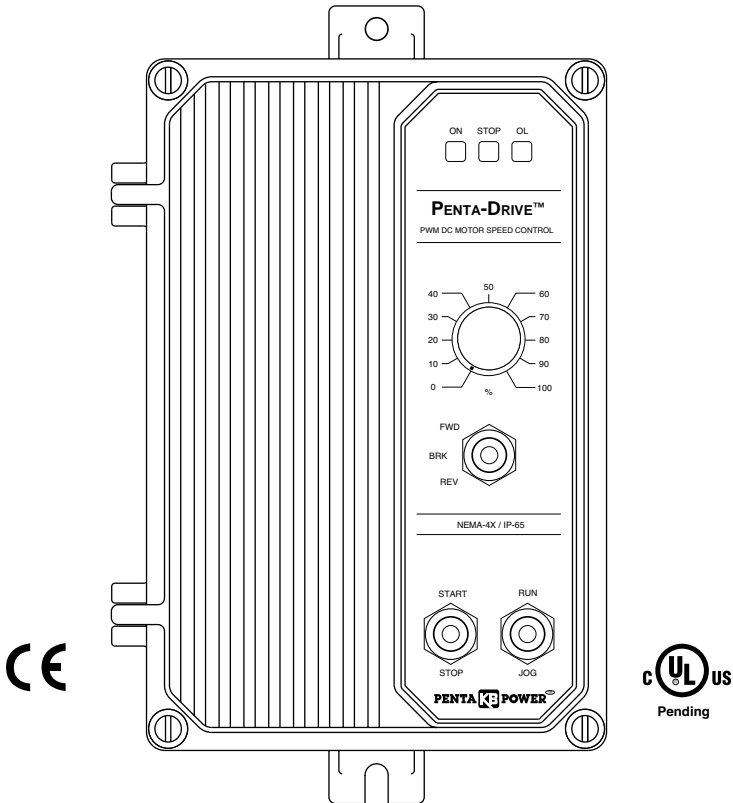

See Safety Warning on Page 2

The information contained in this manual is intended to be accurate. However, the manufacturer retains the right to make changes in design which may not be included herein.

PENTA KB POWER™

A COMPLETE LINE OF MOTOR DRIVES

TABLE OF CONTENTS

Section	Page
i. Safety Warning	1
I. Introduction	1
II. Simplified Operating Instructions	2
III. Wiring Instructions	6
IV. Setting Selectable Jumpers	9
V. Mounting Instructions	11
VI. Operation	12
VII. AC Line Fusing	12
VIII. Trimpot Adjustments	12
IX. Diagnostic LEDs	13
X. Optional Accessories	14
XI. Limited Warranty	18
Tables	
1. Electrical Ratings	3
2. General Performance Specifications	3
3. Terminal Block Wiring Information	6
4. Field Connection (Shunt Wound Motors Only)	7
5. Setting Motor Current (SCR & PWM Motor Horsepower Ratings)	10
Figures	
1. Control Layout	4
2. Mechanical Specifications	5
3. Power Connection	6
4. Full Voltage Field	7
5. Half Voltage Field	7
6. Remote Potentiometer	7
7. Remote Start/Stop Switch	8
8. Voltage Following	8
9. Inhibit Circuit	8
10. Enable Circuit	9
11. DC Tach-Generator	9
12. Motor Voltage Selection	9
13. Motor Current Selection	9
14. Removing Resistor R35 (for low current selection)	10
15. Current Limit Mode Selection	10
16. DC Tach-Generator Voltage Selection	11
17. DC Tach-Generator with Addition of R _T	11
18. Run Relay Output Mode Selection	12

i.  **SAFETY WARNING! Please read carefully**

This product should be installed and serviced by a qualified technician, electrician, or electrical maintenance person familiar with its operation and the hazards involved. Proper installation, which includes wiring, mounting in proper enclosure, fusing or other overcurrent protection, and grounding can reduce the chance of electrical shocks, fires, or explosion in this product or products used with this product, such as electric motors, switches, coils, solenoids, and/or relays. Eye protection must be worn and insulated adjustment tools must be used when working with control under power. This product is constructed of materials (plastics, metals, carbon, silicon, etc.) which may be a potential hazard. Proper shielding, grounding, and filtering of this product can reduce the emission of radio frequency interference (RFI) which may adversely affect sensitive electronic equipment. If further information is required on this product, contact the factory. It is the responsibility of the equipment manufacturer and individual installer to supply this Safety Warning to the ultimate end user of this product. (SW effective 11/1992.)

This control contains electronic Start/Stop circuits that can be used to start and stop the control. However these circuits are never to be used as safety disconnects since they are not fail-safe. Use only the AC line for this purpose.

Be sure to follow all instructions carefully. Fire and/or electrocution can result due to improper use of this product.



PWM Safety Warning! This control contains a safety circuit which is designed to prevent full speed runaway in the event the main power transistor fails. However, this safety circuit is not infallible and may itself fail to operate and therefore allow a full speed runaway condition to exist. The installer of this product should take proper precautions to include other means to protect the operator or the machine involved (such as mechanical disconnects, warning notices, etc.).



This product complies with all CE directives pertinent at the time of manufacture. Contact factory for detailed installation and Declaration of Conformity. Installation of a CE approved RFI filter (KBRF-200A [P/N 9945C] or equivalent) is required. Additional shielded motor cable and/or AC line cables may be required along with a signal isolator (KBSI-240D [P/N 9431] or equivalent).

I. INTRODUCTION

Thank you for purchasing the KBPW-240D. KB Electronics, Inc. is committed to providing total customer satisfaction by producing quality products that are easy to install and operate. The KBPW-240D is manufactured with surface mount components incorporating advanced circuitry and technology.

The KBPW-240D is a Pulse Width Modulated (PWM) control in a NEMA-4X / IP-65 watertight and washdown enclosure designed to operate PWM and SCR rated Permanent Magnet and Shunt Wound motors ranging from 0.2 Amps DC to 7.5 Amps DC. It operates at a switching frequency greater than 16kHz to provide high motor efficiency and quiet operation. **Special circuitry automatically accepts AC line input voltages of 115 Volts AC to 208/230 Volts AC ($\pm 10\%$, 50/60Hz) without having to make a jumper selection.**

Standard panel mounted features include diagnostic LEDs (power on, stop, and overload), Start/Stop switch, and speed potentiometer. Other features include barrier terminal blocks (facilitate wiring of AC line, motor armature, motor field, tach-generator and run relay connections), adjustable trim pots (acceleration, deceleration, maximum speed, minimum speed, jog speed [used with optional Run/Jog switch], current limit, timed current limit and IR Comp.)

Optional accessories include On/Off AC Line Switch, FWD-BRK-REV Switch, Run-Stop-Jog Switch, Signal Isolator, and Anti-Plug Reversing Module. Quick-connect terminals are provided for easy installation of all optional accessories. The control is available in black finish (P/N 8401) and FDA approved white finish (P/N 8402).

STANDARD FEATURES

- **Short Circuit Protection** – Protects control from a short circuit at motor connections.
- **Electronic Motor Burnout Protection** – Shuts down the control if a prolonged overload condition exists.
- **Active Bridge** – Limits the AC line inrush current when power is turned on and also prevents high speed runaway if the power transistor shorts.
- **Heat Spreader** – Allows power transistor to operate safely during momentary overload conditions.
- **Auto AC Line Select** – Control automatically adjusts for 115 or 208/230 Volt AC line input.
- **Start/Stop Switch** – Provides electronic start and stop functions.
- **Diagnostic LEDs** – For power on (ON), stop (STOP) and motor overload (OL).
- **Trimpots** – Provide adjustment for acceleration (ACCEL), deceleration (DECEL), maximum speed (MAX), minimum speed (MIN), jog speed (JOG), current limit (CL), timed current limit (TCL), and IR compensation (IR).
- **Selectable Jumpers** – Provide settings for armature voltage or tach-generator feedback (J1), motor current (J2), timed or non-timed current limit (J3), tach-generator voltage (J4), and run relay output (J5).
- **Barrier Terminal Blocks** – Facilitate wiring of AC line, motor armature and field, tach-generator, and run relay output.
- **Quick-Connect Terminals** – Facilitate connecting Start/Stop switch, Run-Stop-Jog switch, FWD-BRK-REV switch, and Inhibit switch.

II. SIMPLIFIED OPERATING INSTRUCTIONS

IMPORTANT – You must read these simplified operating instructions before proceeding. These instructions are to be used as a reference only and are not intended to replace the detailed instructions provided herein. You must read the Safety Warning, on page 1, before proceeding.

A. Power Connection – Connect the AC line to L1 and L2 terminals of TB1 and the ground wire (Earth) to the green ground screw as shown in Figure 3, on page 6 and as described in Section IIIA, on page 6 and Section IIIB, on page 6.

B. Permanent Magnet (PM) Motor Connection (Two-Wire Type) – Connect the motor armature to A1 (+) and A2 (-) terminals of TB1 as shown in Figure 3, on page 6 and as described in Section IIIC, on page 6. Be sure that jumper J3 is set to the corresponding motor voltage position as described in Section IVA, on page 9. **Do not use F1 and F2 terminals of TB2 for any purpose other than to power the field of a shunt wound motor. Do not use F1 and F2 terminals for PM motors.**

Note: Motor performance and efficiency, including brush life, may be adversely affected when operating the control in stepdown mode (208/230 Volt AC line with 90/130 Volt DC motors).

C. Shunt Wound Motors (Four-Wire Type) – Connect the motor armature as described in Section IIIC, on page 6. Connect full voltage field wires (90 Volt DC motors with 100 Volt DC field and 180 Volt DC motors with 200 Volt DC field) to F1 (+) and F2 (-) terminals of TB2 as described in Section IIID, on page 7. Connect half voltage field wires (90 Volt DC motors with 50 Volt DC field and 180 Volt DC motors with 100 Volt DC field) to F1 (+) terminal of TB2 and L1 (-) terminal of TB1 as described in Section IIIE, on page 7.

Note: Do not connect motor armature leads to F1 and F2 terminals.

D. Motor Current – Jumper J2 is factory set for 7.5 Amp motors. For lower current motors, set jumper J2 to the corresponding motor current as described in Section IVB, on page 9.

Note: The factory setting for Current Limit is 150% of the nominal current setting (example: if jumper J2 is set to “5A” position, the CL trimpot is calibrated for 7.5 Amps).

E. Trimpot Settings – All trimpots have been factory set as shown in Figure 1, on page 4. Trimpots may be readjusted as described in Section VIII, on page 12.

F. Diagnostic LEDs – After power has been applied, observe the LEDs to verify proper control function as described in Section IX, on page 13.

G. Start/Stop Switch – The control is supplied with a prewired Start/Stop switch as described in Section IIIG, on page 8. This switch must be used to start the control each time the AC power is lost or the control shuts down in TCL. To override this function, see Section IIIG, on page 8.

TABLE 1 – ELECTRICAL RATINGS

AC Line Voltage (±10%, 50/60 Hz) (Volts AC)	Motor Voltage (Volts DC)	Maximum AC Line Current (Amps RMS)	Maximum Load Current (Amps DC)	Maximum Horsepower HP, (kW)		Field Voltage (Volts DC)
				SCR Rated Motors	PWM Rated Motors	
115	0 – 90, 130	11.5	7.5	3/4, (0.5)	1, (0.75)	100
208 – 230	0 – 180, 260	11.5	7.5	1½, (1)	2, (1.5)	200

TABLE 2 – GENERAL PERFORMANCE SPECIFICATIONS

Parameter	Specification	Factory Setting
Operating Frequency (kHz)	>16	–
Operating Temperature Range at Full Rating (°C)	0 – 50	–
Current Range (High Scale) (Amps DC)	1.7, 2.5, 3.5, 5.0, 7.5	7.5
Current Range (Low Scale) (Amps DC) ¹	0.2, 0.3, 0.4, 0.5, 0.8	–
ACCEL and DECEL Range (Seconds)	0.5 – 10	1
Jog Speed (% Base Speed)	0 – 50	15
MIN Speed Range (% Base Speed [90VDC & 180VDC Motors])	0 – 30	0
MAX Speed Range (% Base Speed [90VDC & 180VDC Motors])	50 – 140	100
IR Comp Range at 90 Volts DC Output (ΔVolts DC at Full Load)	0 – 15	4
IR Comp Range at 180 Volts DC Output (ΔVolts DC at Full Load)	0 – 30	8
CL Range (% Range Setting)	0 – 200	150
Timed Current Limit (TCL) Range (Seconds)	0.5 – 10	5
AC Line Input Voltage (Volts AC, ±10%, 50/60 Hz)	115 – 208/230	–
AC Line Regulation (% Base Speed)	0.5	–
Armature Voltage Range at 115 Volts AC Line Input (Volts DC)	0 – 130	90
Armature Voltage Range at 208/230 Volts AC Line Input (Volts DC)	0 – 130 ² , 0 – 260	90
Armature Feedback Load Regulation (% Base Speed)	1	–
Tach-Generator Feedback Load Regulation (% Set Speed)	1	–
Field Voltage at 115 Volts AC Line Input (Volts DC)	100/50	–
Field Voltage at 208/230 Volts AC Line Input (Volts DC)	200/100	–
Speed Range (Ratio)	50:1	–
Voltage Following Linearity (% Base Speed)	±0.5	–

1. For low current operation, remove resistor R35 as described in section IVB, on page 9

2. Step-down operation – Motor may have reduced brush life – Consult motor manufacturer.

FIGURE 1 – CONTROL LAYOUT

(Illustrates Factory Setting of Jumpers and Approximate Trimpot Settings)

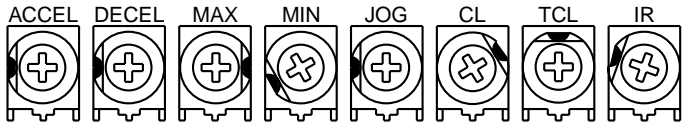
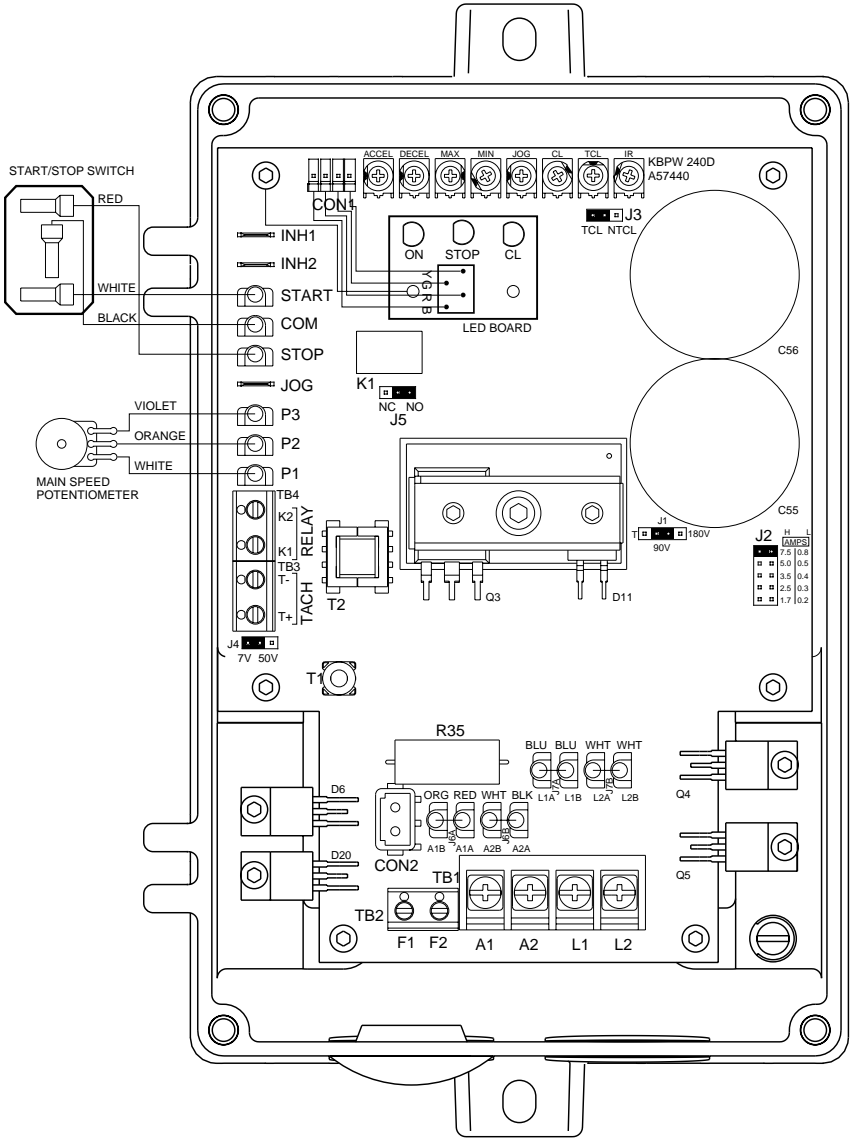

Enlarged view of trimpots

FIGURE 2 – MECHANICAL SPECIFICATIONS (INCHES / [mm])

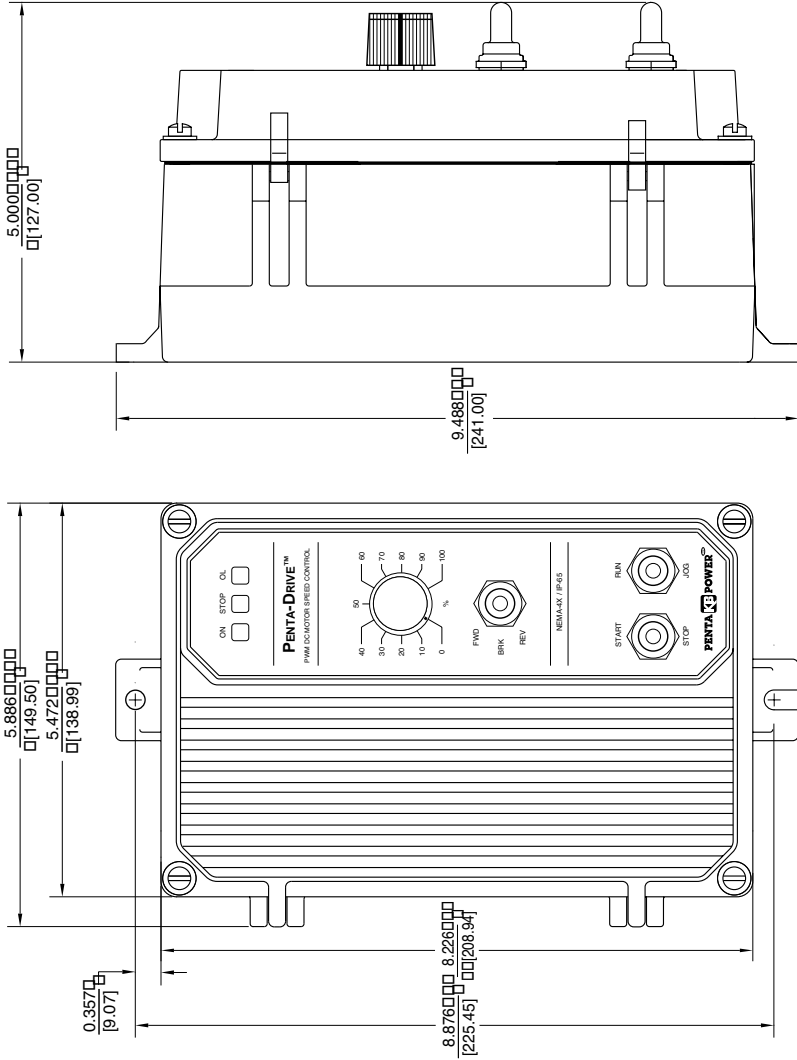

CONTROL SHOWN WITH OPTIONAL FWD-BRK-REV AND RUN-STOP-JOG SWITCHES

III. WIRING INSTRUCTIONS



Warning! Read Safety Warning, on page 1, before using this control. Disconnect the AC line before wiring.

Note: To avoid erratic operation, do not bundle AC line and motor wires with wires from signal following, start/stop switch, inhibit, or any other signal wires. Use shielded cables on all signal wiring over 12" (30cm). Shield should be Earth grounded on the control side only. Wire the control in accordance with the National Electrical Code requirements and other codes that may apply to your area. See Figure 3, Table 3 and Table 4, on page 7.

FIGURE 3 – POWER CONNECTION

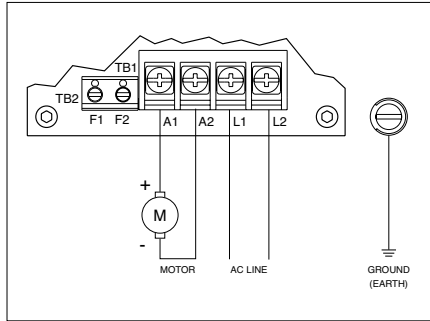

TABLE 3 – TERMINAL BLOCK WIRING INFORMATION

Terminal Block	Designation	Connections	Supply Wire Gauge (AWG - Cu)		Maximum Tightening Torque (in-lbs)
			Minimum	Maximum	
TB1	AC Line Input	L1 & L2	22	12	12
TB1	Motor Armature	A1 & A2	22	12	12
TB2	Motor Field (Shunt Wound Motors Only)	F1 & F2	24	14	3.5
TB3	Tach-Generator	T+ & T-	24	14	3.5
TB4	Run Relay	K1 & K2	24	14	3.5

Be sure to properly fuse each conductor that is not at ground potential. **Do not fuse neutral or grounded conductors. See Section VII, on page 12.** A separate AC line switch or contactor must be wired as a disconnect so that each ungrounded conductor is opened. An accessory On/Off AC Line Switch (P/N 9341) may be used in lieu of, or in addition to, the Start/Stop switch. The switch can be wired for single pole or double pole operation, as required.

To maintain the watertight integrity of the control, be sure to use suitable watertight connectors and wiring which are appropriate for the application. Two 7/8" (22.2mm) knockout holes are provided for standard 1/2" knockout connectors (not supplied) for wiring. A watertight plug is provided if only one knockout is required.



Warning! Do not wire switches or relays in series with the armature. Armature switching can cause catastrophic failure of motor and/or control. To avoid erratic operation, do not bundle AC line and motor wires with potentiometer wires, voltage following wires, Start/Stop switch wires, inhibit wires, or any other signal wires. Use shielded cables on all signal wiring over 12" (30cm) long. Shield should be Earth grounded on the control side only. **Warning! Do not use CON2 for any purpose other than to power the optional Anti-Plug Reversing Module APRM-PC (P/N 9378A).**

- A. AC Line Connection** – Wire AC line input to L1 and L2 terminals of TB1 as shown in Figure 3.
- B. Ground Connection** – Earth ground the control chassis using the green ground screw that is provided on the inside of the control to the right side of TB1 as shown in Figure 3.
- C. Permanent Magnet (PM) Motor Connection** – Wire the motor armature leads to A1 (+) and A2 (-) terminals of TB1 as shown in Figure 3. Be sure jumper J1 is set to the appropriate motor voltage and that J3 is set to the appropriate motor current. For step-down

operation (230 Volt AC line input with 90 Volt DC SCR rated motor or 130 Volt DC PWM rated motor) set jumper J1 to "90V" position. However, in step-down operation the motor may have reduced brush life - consult motor manufacturer.

Note: Do not connect motor armature leads to F1 and F2 terminals. Do not use F1 and F2 terminals for PM motors.

D. Full Voltage Field Connection (Shunt Wound Motors Only) – Wire the motor field leads to F1 (+) and F2 (-) terminals of TB2 as shown in Figure 4 and Table 4.

Note: Do not connect motor armature leads to F1 and F2 terminals.

Warning! Do not use F1 and F2 terminals of TB2 for any purpose other than to power the field of a shunt wound motor.

E. Half Voltage Field Connection (Shunt Wound Motors Only) – Wire the motor field leads to F1 (+) and L1 (-) terminals of TB2, as shown in Figure 5 and Table 4.

Note: Do not connect motor armature leads to F1 and F2 terminals.

Warning! Do not use F1 and F2 terminals of TB2 for any purpose other than to power the field of a shunt wound motor.

FIGURE 4 – FULL VOLTAGE FIELD

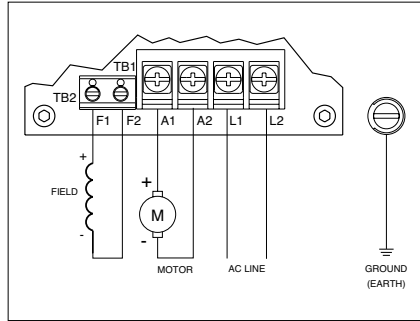

FIGURE 5 – HALF VOLTAGE FIELD

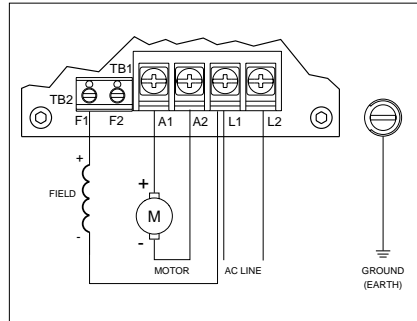
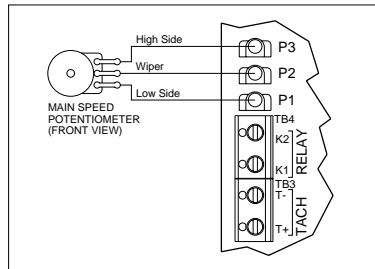

TABLE 4 – FIELD CONNECTION (Shunt Wound Motors Only)

AC Line Voltage (Volts AC)	Armature Voltage (Volts DC)	Field Voltage (Volts DC)	Field Connections
115	90 – 130	100	F1 & F2
115	90 – 130	50	F1 & L1
230	180 – 260	200	F1 & F2
230	180 – 260	100	F1 & L1
230	90 – 130	100	F1 & L1

F. Remote Main Speed Potentiometer Connection – The control is supplied with a prewired main speed potentiometer mounted on the front cover. To operate the control from a remote potentiometer (5kΩ), remove the white, orange, and violet potentiometer leads from P1, P2, and P3 terminals, respectively. The leads may be taped and left inside the control. The potentiometer assembly may be removed if a watertight seal is used to cover the hole in the front cover. Connect the remote main speed potentiometer wires to terminals P1 (low side), P2 (wiper), and P3 (high side) as shown in Figure 6.

FIGURE 6 – REMOTE POTENTIOMETER



G. Remote Start/Stop Switch Connections – The control is supplied with a prewired Start/Stop switch mounted on the front cover. To operate the control from a remote Start/Stop switch (type: (ON)-OFF-ON, SPDT), remove the white, black, and red wires from START, COM, and STOP terminals, respectively. The leads may be taped and left in the control. The switch itself may be removed if a watertight seal is used to cover the hole in the front cover. Connect the remote Start/Stop switch wires to START (momentary), COM (common), and STOP (constant) terminals as shown in Figure 7. After applying power, momentarily set the Start/Stop switch to “START” position. The motor will operate at the set speed of the main speed potentiometer. To stop the motor, set the Start/Stop switch to “STOP” position.

FIGURE 7 – REMOTE START/STOP SWITCH

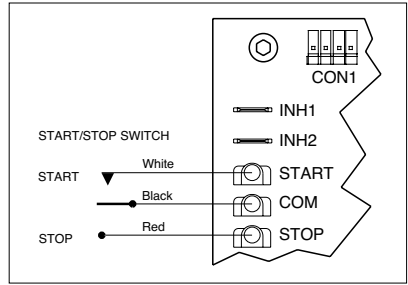

Note: To eliminate the Start/Stop function, connect the START and COM terminals with the jumper that is provided.

CAUTION! Eliminating the Start/Stop function using a jumper will cause the motor to run at the main speed potentiometer setting when the AC line is applied.

H. Run Relay Connection – Normally open (NO) or normally closed (NC) relay output contacts are available at TB4, which will change state when the Start/Stop switch is set to “START” position or if the control shuts down and goes into STOP mode from TCL. The run relay is used to indicate the state of the control (run or stop). Normally open or normally closed run relay contact outputs can be selected depending on the position of jumper J5. If normally open is selected (J5 in “NO” position), the run relay output contacts will close when the Start/Stop switch is set to “START” position. If normally closed is selected (J5 set to “NC” position), the run relay output contacts will open when the Start/Stop switch is set to “START” position. When the control shuts down and goes into STOP mode from TCL, or the Start/Stop switch is set to “STOP” position, the Run Relay output contacts will return to their normal position.

Note: If relay output contacts are not required for your application, J5 may be in any position.

FIGURE 8 – VOLTAGE FOLLOWING

I. Voltage Following Connection – An isolated 0 - 10 Volt DC analog signal can also be used to control motor speed. See Figure 8.

Note: If an isolated signal voltage is not available, an optional signal isolator can be installed (KBSI-240D, P/N 9431). Connect the isolated signal voltage to P2 (+) and P1 (-) terminals. Adjustment of the MIN trimpot may be necessary to achieve a 0 Volt DC output.

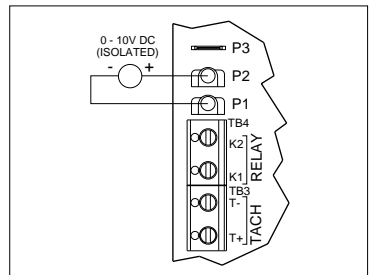

J. Inhibit Connection – The control is supplied with inhibit terminals (INH1 and INH2) to connect an Inhibit switch. See Figure 9. These terminals are used to electronically stop the control. When the Inhibit switch is closed, the control will coast to stop. When the Inhibit switch is opened, the control will accelerate to the main speed potentiometer setting.

FIGURE 9 – INHIBIT CIRCUIT

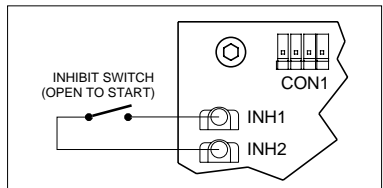

Warning! Do not use Inhibit as a safety disconnect. Use only the AC line for this purpose.

K. Enable Connections – The control can also be started and stopped with an Enable circuit (close to start). See Figure 10. This circuit functions opposite to that of the Inhibit circuit (open to start). The Enable function is established by wiring a switch in series with the violet main speed potentiometer lead which connects to the P3 terminal. When the Enable switch is closed, the control will accelerate to the main speed potentiometer setting. When the Enable switch is opened, the control will coast to stop.

 **Warning! Do not use Enable as a safety disconnect. Use only the AC line for this purpose. P3 terminal is not isolated and is not to be Earth grounded.**

FIGURE 10 – ENABLE CIRCUIT



L. DC Tach-Generator Connection – Wire the tach-generator to T+ (+) and T- (-) terminals of TB4 as shown in Figure 11. Jumper J1 must be in “T” position. Jumper J4 must be in “7V” position for 7 Volt per 1000 RPM tach-generators or “50V” position for 50 Volt per 1000 RPM tach-generators. See section IVD on page 11.

Note: When using a tach-generator, the IR trimpot should be set fully counter-clockwise.

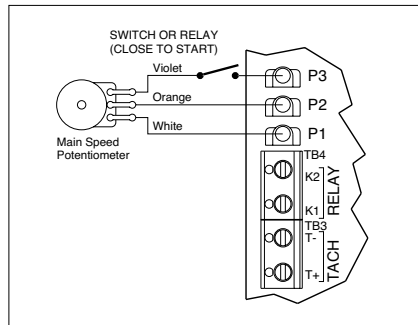
FIGURE 11 – DC TACH-GENERATOR

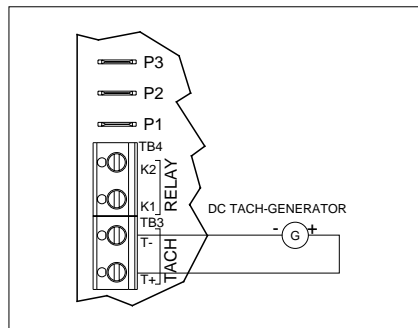

IV. SETTING SELECTABLE JUMPERS

The KBPW-240D has customer selectable jumpers which must be set before the control can be used. See Figure 1, on page 4 for location of jumpers.

A. Motor Voltage Selection (J1) – Jumper J1 is factory set to “90V” position for 90 Volt SCR rated motors (or 130 Volt PWM rated motors). For 180 Volt SCR rated motors (or 220 Volt PWM rated motors), set jumper J1 to “180V” position. See Figure 12.

FIGURE 12 – MOTOR VOLTAGE SELECTION

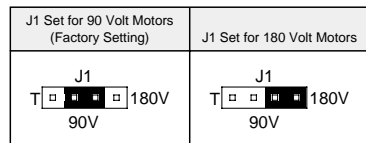

Note: If jumper J1 is set to “T” position, a tach-generator must be wired to TB3. If a tach-generator is not used, jumper J1 must be in either “90V” or “180V” position. If jumper J1 is in “T” position and a tach-generator is not used, the motor will accelerate to full speed and the main speed potentiometer will not control speed.

FIGURE 13 – MOTOR CURRENT SELECTION

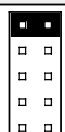
J2 Set for 7.5 Amp Motor (Factory Setting)	High Scale Current Range (Amps DC)	Low Scale Current Range* (Amps DC)
	7.5	0.8
	5.0	0.5
	3.5	0.4
	2.5	0.3
	1.7	0.2

B. Motor Current Selection (J2) – Jumper J2 is factory set to “7.5A” position for 7.5 Amp motors.

***Note:** For low (L) motor current range settings (0.8A, 0.5A, 0.4A, 0.3A and 0.2A), it is necessary to remove resistor R35 by cutting it out of the circuit as shown in figure 14 on page 10.

For motors of lower amperage, set jumper J2 to the corresponding position for the motor being used. See Figure 13 on page 9 and Table 5.

Note: For low (L) motor current settings (0.8A, 0.5A, 0.4A, 0.3A, and 0.2A), it is necessary to remove resistor R35 by cutting it out of the circuit. Cut the leads at the locations shown in Figure 14.

FIGURE 14 – REMOVING RESISTOR R35

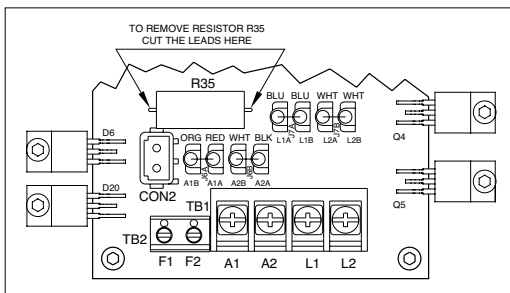

WARNING! Disconnect AC line before cutting out resistor R35. Use an insulated cutter and wear safety glasses.

TABLE 5 – SETTING MOTOR CURRENT (SCR & PWM Motor Horsepower Ratings)

J2 Setting (Amps DC)	SCR Rated Motor Horsepower HK, (kW)		PWM Rated Motor Horsepower HP, (kW)	
	90 Volts DC Motors	180 Volts DC Motors	130 Volts DC Motors	220Volts DC Motors
7.5	3/4, (0.5)	1½, (1)	1, (0.75)	2, (1.5)
5.0	1/2, (0.37)	1, (0.75)	3/4, (0.5)	1½, (1)
3.5	1/3, (0.25)	3/4, (0.5)	1/2, (0.37)	1, (0.75)
2.5	1/4, (0.18)	1/2, (0.37)	1/3, (0.25)	3/4, (0.5)
1.7	1/6, (0.1)	1/3, (0.25)	1/4, (0.18)	1/2, (0.37)
0.8*	1/12, (0.06)	1/6, (0.1)	1/8, (0.09)	1/4, (0.18)
0.5*	1/20, (0.04)	1/10, (0.08)	1/15, (0.05)	1/6, (0.1)
0.4*	1/25, (0.03)	1/12, (0.06)	1/20, (0.04)	1/8, (0.09)
0.3*	1/30, (0.02)	1/15, (0.05)	1/25, (0.03)	1/10, (0.08)
0.2*	1/50, (0.01)	1/25, (0.03)	1/30, (0.02)	1/20, (0.04)

*Note: For low (L) motor current range settings (0.8A, 0.5A, 0.4A, 0.3A and 0.2A), it is necessary to remove resistor R35 by cutting it out of the circuit as shown in figure 14.

C. Timed and Non-Timed Current Limit Selection (J3) – Jumper J3 is factory set to “TCL” position for timed current limiting operation. See Figure 15. For non-timed current limiting operation, set jumper J3 to “NTCL” position.

TCL (Timed Current Limit) – When jumper J3 is set to “TCL” position, the control will go into “STOP” after it is in overload for a predetermined amount of time (set by the TCL trimpot).

Resetting the Control After TCL – To reset the control after it has gone into TCL, momentarily set the Start/Stop switch to “START” position or disconnect and reconnect the AC line. If an On/Off AC Line Switch is installed, set it to “OFF” position and then back to “ON” position. If the Start switch is jumpered (START and COM terminals connected), the control must be restarted by disconnecting and reconnecting the AC line.

FIGURE 15 – CURRENT LIMIT MODE SELECTION

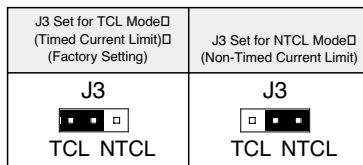



NTCL (Non-Timed Current Limit) – When jumper J3 is set to “NTCL” position, the control will not go into “STOP” after it is in overload.

Note: TCL trimpot will have no affect when jumper J3 is in “NTCL” position.

- D. DC Tach-Generator Voltage Selection (J1 and J4)** – For a tach-generator wired to TB3, set jumper J1 to “T” position. See Figure 16. Jumper J4 is factory set to “7V” position for 7 Volt per 1000 RPM tach-generators wired to TB3. For a 50 Volt per 1000 RPM tach-generator, set jumper J4 to “50V” position.

Note: When using a tach-generator, the IR trimpot should be set fully counterclockwise.

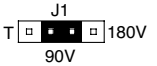
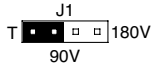
FIGURE 16 – DC TACH-GENERATOR VOLTAGE SELECTION

Jumper J1 Settings		Jumper J4 Settings	
J1 Set for 90 Volt Motors □ (Factory Setting)	J1 Set for □ Tach-Generator Input	J4 Set for 7V per 1000RPM □ Tach-Generator Input □ (Factory Setting)	J4 Set for 50V per 1000RPM □ Tach-Generator Input
			

Note: The tach-generator input is designed for 7 Volt or 50 Volt per 1000 RPM tach-generators used with 1800 RPM motors. For tach-generators other than 7 Volt or 50 Volt per 1000 RPM or for motors other than 1800 RPM, an external 1/2 watt resistor (R_T) must be used. Install R_T in series with the tach-generator as shown in Figure 17. Jumper J4 must be set to “7V” position.

The value of R_T in Ω can be calculated using the following formula:

$$R_T = (1.46 \times V_T \times S) - 19,000$$

Where V_T is the tach-generator voltage (in Volts per 1000 RPM) and S is the base speed of the motor (in RPM).

Example:

Suppose you have a 20 Volt per 1000 RPM tach-generator with a 3600 RPM motor:

$$R_T = (1.46 \times 20 \times 3600) - 19000 = 86120\Omega.$$

Choose the closest 1/2W resistor value, which is 82000 Ω (82k Ω) or 91000 Ω (91k Ω). Readjustment of the MAX trimpot may be necessary to achieve the desired maximum output voltage.

- E. Run Relay Output Mode Selection (J5)** – Jumper J5 is factory set to “NO” position for normally open relay output at TB4. For normally closed relay output, set jumper J5 to “NC” position. See Figure 18, on page 12.

FIGURE 17 – DC TACH-GENERATOR WITH ADDITION OF R_T

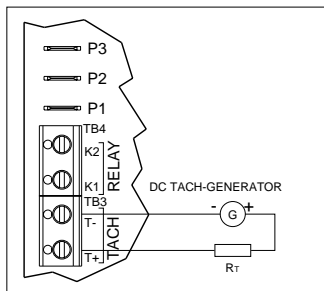

V. MOUNTING INSTRUCTIONS





Warning! The KBPW-240D is not designed to be used in an explosion-proof application.

It is recommended that the control be mounted vertically on a flat surface with adequate ventilation. Leave enough room below the control to allow for AC line, motor connections, and any other wiring. Although the control is designed for outdoor and washdown use, care should be taken to avoid extreme hazardous locations where physical damage can occur. If the control is mounted in a closed, unventilated location, allow enough room for proper heat dissipation. If operating the control at full rating, a minimum enclosure size of 12”W x 24”H x 12”D is required. See Figure 2, on page 5.

The KBPW-240D is designed with a hinged case so that when the front cover is open, all wiring stays intact. To open the cover, the four screws must be loosened so they are no longer engaged in the case bottom. After mounting and wiring, close the cover and make sure that wires will not get caught or crimped as the cover is closed. Tighten all four cover screws so that the gasket is slightly compressed. **Do not over tighten.**

FIGURE 18 – RUN RELAY OUTPUT MODE SELECTION

J5 Set for Normally Open <input type="checkbox"/> (NO) Output Contacts <input type="checkbox"/> (Factory Setting)	J5 Set for Normally Closed <input type="checkbox"/> (NC) Output Contacts
J5  NC NO	J5  NC NO

VI. OPERATION

After the control has been properly setup (jumpers set to desired positions and wiring completed), the startup procedure can begin. If AC power has been properly brought to the control, the ON and STOP LEDs will be illuminated. Before starting, be sure the main speed potentiometer is fully counterclockwise. To start the control, momentarily set the Start/Stop switch to “START” position and release it. The STOP LED should no longer illuminate. The motor should begin to rotate, as the main speed potentiometer is rotated clockwise.

Note: If the motor rotates in the incorrect direction, it will be necessary to disconnect the AC line, reverse the motor leads, and repeat the startup procedure.

VII. AC LINE FUSING

This control does not contain AC line fuses. Most electrical codes require that each ungrounded conductor contain circuit protection. Installation of a 20 Amp fuse or circuit breaker in series with each ungrounded conductor is recommended. Check all electrical codes that apply to the application.

VIII. TRIMPOT ADJUSTMENTS

The KBPW-240D contains trimpots, which are factory set for most applications. Figure 1, on page 4, illustrates the location of the trimpots and their approximate calibrated positions. Some applications may require readjustment of the trimpots in order to tailor the control for a specific requirement. Readjust trimpots as described below.



Warning! If possible, do not adjust trimpots with main power applied. If adjustments are made with main power applied, an insulated adjustment tool must be used and safety glasses must be worn. High voltage exists in this control. Fire and/or electrocution can result if caution is not exercised. Safety Warning, on page 1, must be read and understood before proceeding.

A. Acceleration (ACCEL) – Sets the amount of time for the motor to accelerate from minimum speed to maximum speed. The ACCEL trimpot is factory set for one (1) second. For more rapid acceleration time, rotate the trimpot counterclockwise. For longer acceleration time, rotate the trimpot clockwise.

Note: Rapid acceleration settings may cause the current limit circuit to activate, which will extend the acceleration time.

B. Deceleration (DECEL) – Sets the amount of time for the motor to decelerate from maximum speed to minimum speed. The DECEL trimpot is factory set for one (1) second. For more rapid deceleration time, rotate the trimpot counterclockwise. For longer deceleration time, rotate the trimpot clockwise.

Note: Deceleration time will not be shorter than the maximum coast time of the motor under actual load.

C. Maximum Speed (MAX) – Sets maximum speed of the motor. The MAX trimpot is factory set for 100% of base motor speed. For a higher maximum speed setting, rotate the trimpot clockwise. For a lower maximum speed setting, rotate the trimpot counterclockwise.

- D. Minimum Speed (MIN)** – Sets minimum speed of the motor. The MIN trimpot is factory set for 0% speed. For a higher minimum speed setting, rotate the trimpot clockwise.
- E. Jog Speed (JOG)** – Sets “jog” speed of the motor. The JOG trimpot is factory set for 15% of motor base speed. For a higher jog setting, rotate the trimpot clockwise. For a lower jog setting, rotate the trimpot counterclockwise.

Note: The Jog feature requires installation of the Run-Stop-Jog Switch assembly (P/N 9340).

- F. Current Limit (CL)** – Sets current limit (overload), which limits the maximum current to the motor. The current limit set point is established by the setting of jumper J2 and the setting of the CL trimpot. The CL trimpot is factory set for 150% of J2 range setting. For a higher current limit setting, rotate the trimpot clockwise. For a lower current limit setting, rotate the trimpot counterclockwise. Two modes of current limiting operation are provided: Non-Timed Current Limit (NTCL) and Timed Current Limit (TCL). See Section IVC, on page 10.

CAUTION! Adjusting the CL above 150% of motor rating can cause overheating and demagnetization of some PM motors. Consult the motor manufacturer. Do not leave the motor in a locked condition for more than a few seconds since armature damage may occur.

- G. Timed Current Limit (TCL)** – Sets the time for the control to shut down after being in current limit (provides electronic motor overload protection). The TCL trimpot is factory set for 5 seconds. For increased TCL time, rotate the trimpot clockwise. For decreased TCL time, rotate the trimpot counterclockwise. If the control remains in CL for a predetermined amount of time (set by the TCL trimpot and if jumper J3 is in the “TCL” position), the control will shut down. To reset the control after it has shut down, momentarily set the start/stop switch to the “START” position or disconnect and then reconnect the AC line.



Warning! When the control shuts down in TCL, the AC line voltage is still present in the control.

- H. Non-Timed Current Limit (NTCL)** – When jumper J3 is set to “NTCL” position and an overload condition exists, the control will remain in current limit.
- I. IR Compensation (IR)** – Sets the amount of compensating voltage required to keep the motor speed constant under changing loads. The IR trimpot is factory set for 4 Volts (for 90 Volt DC output) and 8 Volts (for 180 Volt DC output). For higher compensating voltage, rotate the trimpot clockwise. For lower compensating voltage, rotate the trimpot counterclockwise.

Note: If the IR compensation is set too high, unstable (oscillatory) operation will result. If the control is used with a tach-generator, the IR trimpot should be set fully counterclockwise.

IX. DIAGNOSTIC LEDs

The KBPW-240D is designed with LEDs mounted on the front cover to display the control's operational status.

- A. Power On (ON)** – The ON LED will illuminate green when the AC line is applied to the control.

Note: When removing power to the control, the POWER LED will remain illuminated for a few seconds until the DC bus voltage discharges.

- B. Stop (STOP)** – The STOP LED will illuminate yellow when the Start/Stop switch is set to “STOP” position. When AC line is applied, this LED will also be illuminated until the Start/Stop switch is set to “START” position.

- C. Overload (OL)** – The OL LED will illuminate red when the control goes into current limit, indicating that the current limit set point has been reached (set by the CL trimpot and the position of jumper J2). This LED will remain illuminated if the control times out in TCL

(jumper J3 set to "TCL" position). The control can be reset by either setting the start/stop switch to "START" position or by disconnecting and reconnecting the AC line. If the overload condition still exists when the control is restarted or AC line reapplied, the OL LED will illuminate again. If the OL LED remains illuminated during control operation, a fault condition may exist. Possible causes for this condition are as follows:

- Motor is overloaded. Check motor current. If the motor is a shunt wound type, the field may be open or not receiving proper voltage.
- Motor may be defective. Check motor for shorts or grounds.
- CL may be set too low. Check position of CL trimpot and setting of jumper J2.

Note: In some applications, especially those requiring the motor to cycle on and off, or from one speed to another, or from stop to high speeds, the OL LED may blink, indicating a transient overload. This may be a normal condition for the application.

X. OPTIONAL ACCESSORIES

Complete instructions and connection diagrams are supplied with all accessories to facilitate installation.

- A. On/Off AC Line Switch (P/N 9341)** – Disconnects the AC line. Mounts on the enclosure cover and is supplied with a switch seal to maintain watertight integrity.
- B. FWD-BRK-REV Switch (P/N 9339)** – Provides motor reversing and dynamic braking. This switch is equipped with a center off hesitation mechanism, which assures that the motor is fully stopped before it can be reversed. Mounts on the enclosure cover and is supplied with a switch seal to maintain watertight integrity.
- C. Run-Stop-Jog Switch (P/N 9340)** – Selects speed setting from either main potentiometer or JOG trimpot. Mounts on the enclosure cover and is supplied with a switch seal to maintain watertight integrity.
- D. Signal Isolator KBSI-240D (P/N 9431)** – Provides isolation from non-isolated signal sources. Mounts on the inside of the enclosure cover.
- E. Auto/Manual Switch (P/N 9377)** – When used with the KBSI-240D (P/N 9431), it selects either an isolated signal from the KBSI-240D or from the main speed potentiometer. Mounts on the enclosure cover and is supplied with a switch seal to maintain watertight integrity.
- F. Anti-Plug Reversing Module APRM-PC (P/N 9378A)** – Provides electronic braking and reversing. Mounts on the inside of the enclosure cover.
Note: For use with this control, the APRM-PC must be Revision A or newer.
- G. KBRF-200A RFI Filter (P/N 9945C)** – Provides RFI and EMI suppression. Meets CE directives.

XI. LIMITED WARRANTY

For a period of 18 months from the date of original purchase, KB Electronics, Inc. will repair or replace, without charge, devices which our examination proves to be defective in material or workmanship. This warranty is valid if the unit has not been tampered with by unauthorized persons, misused, abused, or improperly installed and has been used in accordance with the instructions and/or ratings supplied. The foregoing is in lieu of any other warranty or guarantee, expressed or implied. KB Electronics, Inc. is not responsible for any expense, including installation and removal, inconvenience, or consequential damage, including injury to any person, caused by items of our manufacture or sale. Some states do not allow certain exclusions or limitations found in this warranty and therefore they may not apply to you. In any event, the total liability of KB Electronics, Inc., under any circumstance, shall not exceed the full purchase price of this product. (rev 2/2000)



KB Electronics, Inc.

12095 NW 39th Street, Coral Springs, FL 33065-2516 • (954) 346-4900 • Fax (954) 346-3377
Outside Florida Call TOLL FREE (800) 221-6570 • E-mail – info@kbelectronics.com
www.kbelectronics.com

RECONDITIONING THE BUS CAPACITORS

If this drive has been in storage for over one year it is necessary to recondition the power supply bus capacitors. To recondition the bus capacitors, apply the AC Line, with the drive in the Stop Mode, for a minimum of one hour. Not following this procedure will cause the bus capacitors to fail.